

MIRA FLIGHT LOW LEVEL SHOWER TRAY

Installation and User Guide

INTRODUCTION

Thank you for purchasing a quality Kohler product. This guide provides comprehensive installation instructions, plus advice on how to care and maintain your product. We recommend that the unit is installed by a competent installer.

GENERAL INFORMATION

1. Read all of these instructions and retain this guide for later use.
2. Pass on this guide in the event of change of ownership of the installation site.
3. Follow all warnings, cautions and instructions contained in this guide.
4. Before installation, carefully remove all of the protective film from the tray for inspection.
5. Carefully unpack and check the tray for colour, size, flatness, general acceptability and compatibility with the shower enclosure and other bathroom furniture.
6. Report any faults immediately to your supplier. No claims will be considered after installation. Fitting this product is acceptance of quality.
7. **Notification to designers, installers and users:** The majority of all shower trays will show an increase in the potential for slipping, when the surface is wet. This is particularly the case when soap, shampoo, bath oil etc. are used.

8. **Caution!** Additional protective coverings such as a dust sheet should be used to protect the tray from damage from falling objects during installation.
9. We recommend this tray is fitted as part of a fully enclosed cubical. If this tray is fitted as a walk-in installation, it is expected that an amount of water will spill onto the open area of the floor. We would therefore advise fixing a threshold strip to minimize this.
Note! Where the shower tray comes into contact with the wall or plaster board surface, apply a liberal amount of silicone sealant before installation. This will help secure the shower tray in position and reduce any rubbing of the surfaces.
10. Hand tighten the waste to ensure a correct seal. Excessive overtightening can lead to damage. **Caution!** Do not stand on waste outlet as damage may occur.
11. Once the waste pipe has been connected pour water into the tray to check the tray and pipe connection for correct drainage prior to final fix and tiling.
12. Excessive flow rates may lead to overflowing and leaking. Flow rate into the tray must not exceed more than 25 litres per minute. We recommend a drainage test is carried out to ensure the waste is adequate for the flow delivered.
13. All legs supplied must be fitted. Make sure that all locking nuts are secured.
14. If you wish to raise the shower tray and not use the legs provided, please contact us for installation advice.

15. The shower tray should be positioned so that the waste is easily accessible for maintenance.
16. Water Spray may extend beyond the entrance of walk-in enclosures and we recommend tiling of the adjacent area.

GUARANTEE

Your product has the benefit of our manufacturer's 10 year guarantee (5 years for any commercial installations) which starts from the date of purchase. **Note!** Wastes, upstand kits and riser kits are guaranteed for 1 year only. For terms and conditions refer to the back cover of this guide.

RECOMMENDED USAGE

Domestic	✓
Light Commercial	✓
Heavy Commercial	✗
Healthcare	✓

PATENTS

Patents: European: 1667 562

INSTALLATION

1 Non Upstand Trays

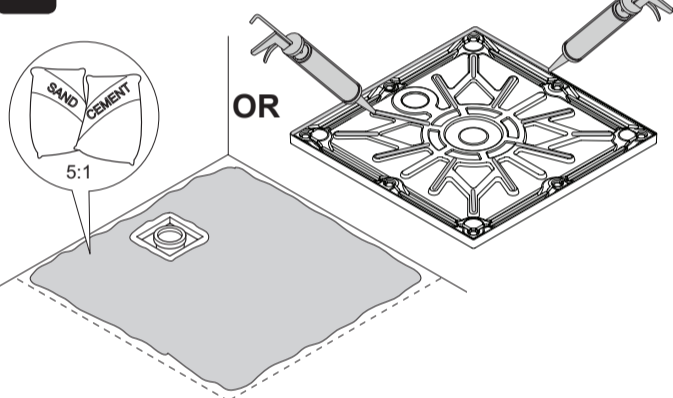

Install the shower tray on a bed of sand and cement or silicone sealant.

2

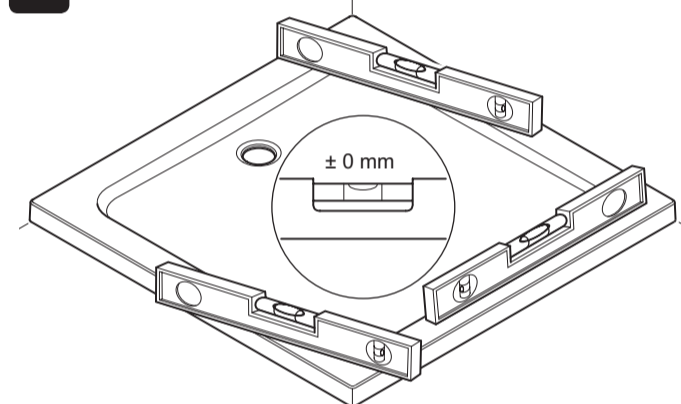

Place the shower tray on a flat surface and using a spirit level check that it is straight and flat and that the shower cubicle will sit on its surface correctly when fitted.

3

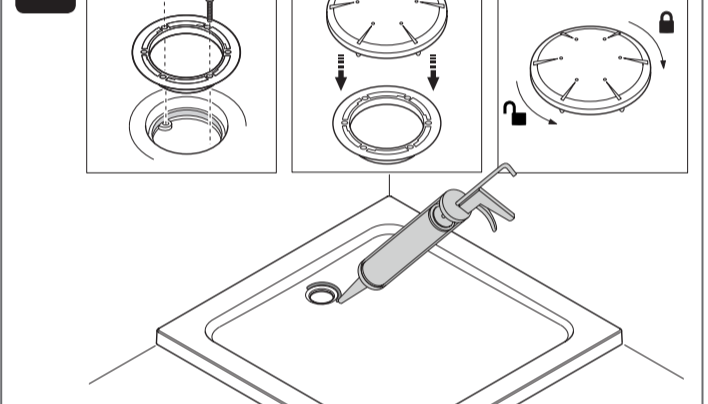

Install the waste. Tighten to ensure a correct seal. Do not overtighten. Install the connecting pipework in accordance with Building Regulations.

4

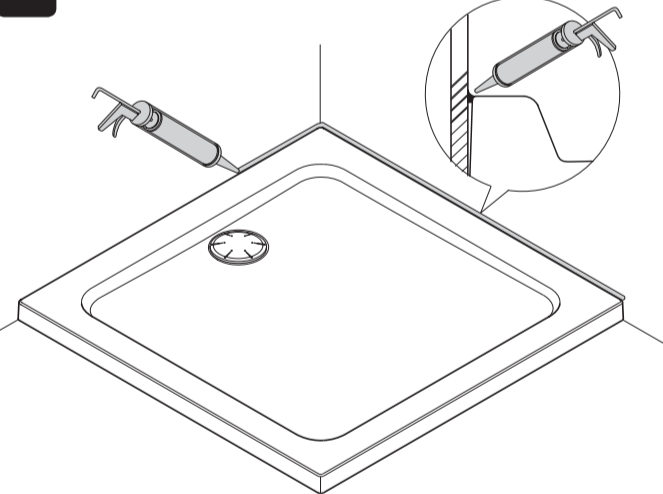

Apply silicone sealant in accordance with the manufacturer's instructions to seal the shower tray to the wall.

5

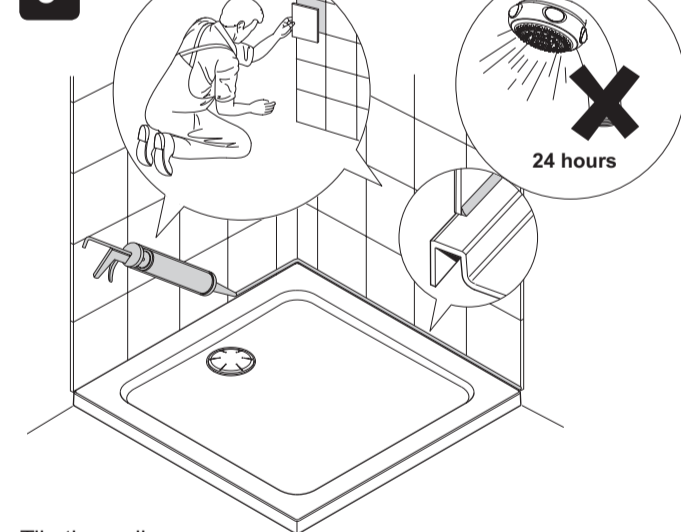

Tile the walls. Apply silicone sealant in accordance with the manufacturer's instructions to seal the shower tray to the tiled wall surface.

INSTALLATION

1 Upstand Trays

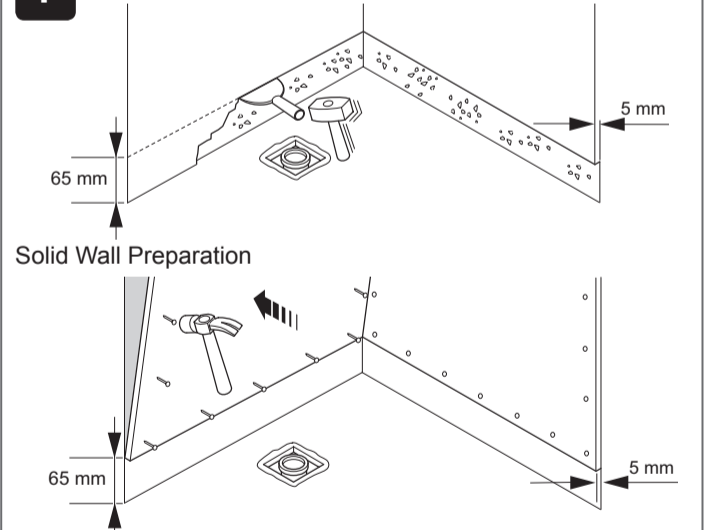

Stud Partition Wall Preparation

4

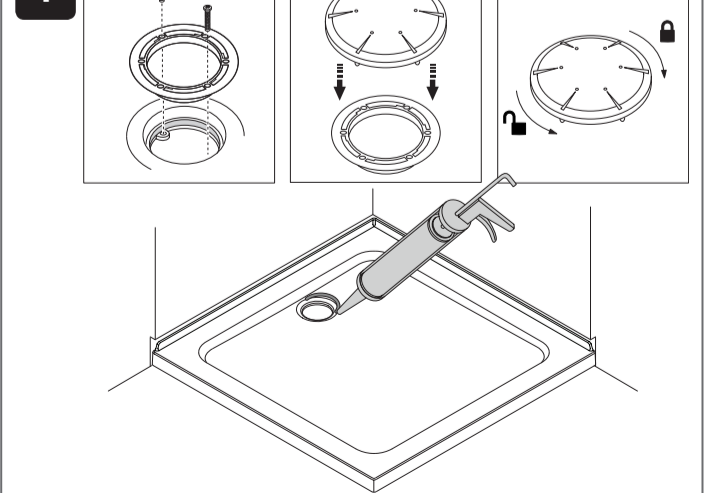

Install the waste. Tighten to ensure a correct seal. Do not overtighten. Install connecting pipework in accordance with Building Regulations.

2

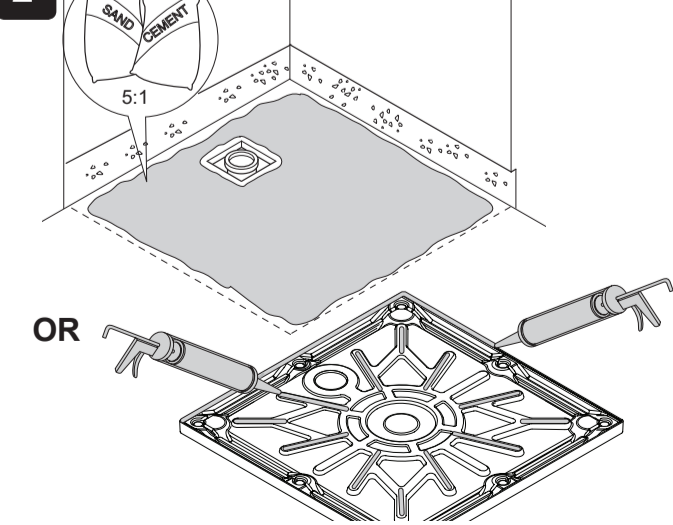

Install the shower tray on a bed of sand and cement or silicone sealant.

3

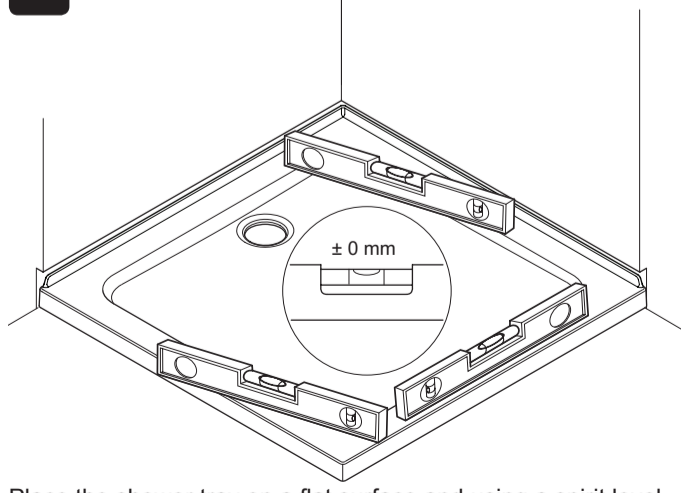

Place the shower tray on a flat surface and using a spirit level check that it is straight and flat and that the shower cubicle will sit on its surface correctly when fitted.

5

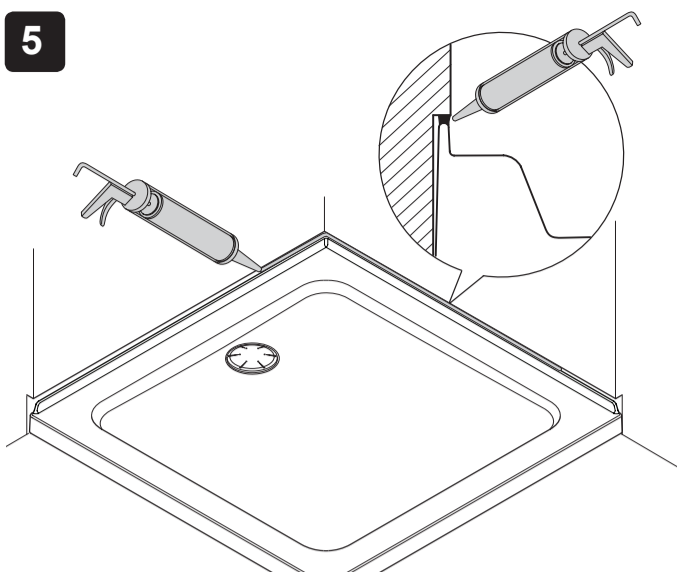

Apply silicone sealant in accordance with the manufacturer's instructions to seal the shower tray to the wall.

6

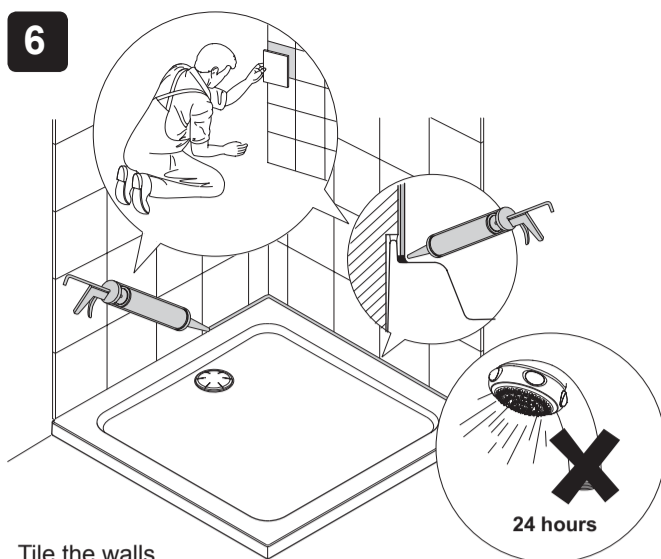

Tile the walls.

Apply silicone sealant in accordance with the manufacturer's instructions to seal the shower tray to the tiled wall surface.

7

If you want to install your shower tray using a riser conversion kit, please refer to the Installation and User Guide packed with the riser kit.

CARE AND MAINTENANCE

Warning! The use of grout/tile cleaners, scale removers, abrasive scourers, drain unblockers and other powerful detergents may lead to damage of metallic, plated and plastic surfaces, including the tray and shower waste.

The acrylic ABS surface of this shower tray has good resistance properties to acids but should not come into contact with alkalis or organic solvents, such as caustic soda, dry cleaning agents and paint strippers.

Hot soapy water should be used and then the tray should be wiped dry with a lint free cloth.

Due to the physical nature of water, small pools may remain on the shower tray after showering. We recommend that both the tray and the enclosure are wiped down with a dry lint free cloth after use.

DIMENSIONS

Rectangle Shower Tray - Non Upstand

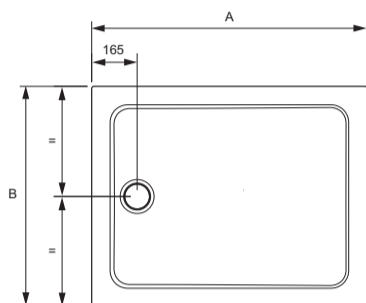

Side Profile of Non Upstand Tray

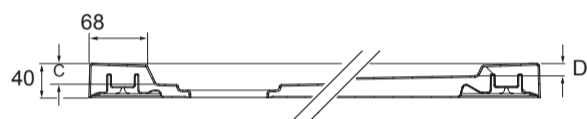

A	B	C	D	Legs
900	760	25	14	9
1000	700	25	12	9
1000	760	25	12	9
1000	800	25	12	9
1100	800	25	12	11
1200	700	25	9	11
1200	760	25	9	11
1200	800	25	9	11
1200	900	25	9	11
1400	700	25	5	13
1400	760	25	5	13
1400	800	25	5	13
1400	900	25	4	13
1500	700	24	3	13
1500	760	24	3	13
1600	700	24	4	13
1600	760	24	4	13
1600	900	24	4	13
1700	700	24	4	13
1700	760	24	4	13
1700	900	24	4	13

Square Shower Tray - Non Upstand

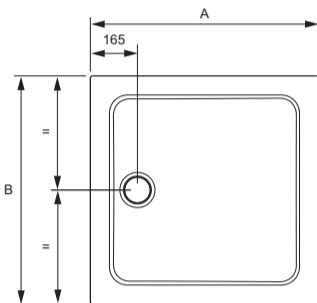

A	B	C	D	Legs
760	760	25	17	9
800	800	25	16	9
900	900	25	14	9
1000	1000	25	12	9

Pentagon Shower Tray - Non Upstand

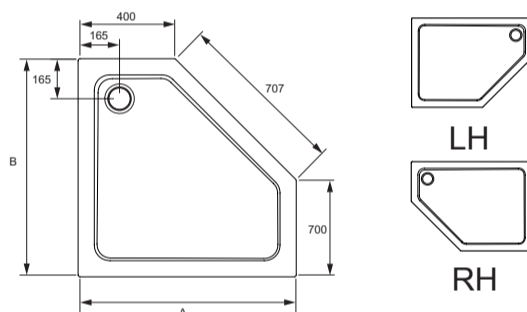

A	B	C	D	Legs
900	900	25	14	9
900	1200	25	9	11

Quadrant Shower Tray - Non Upstand

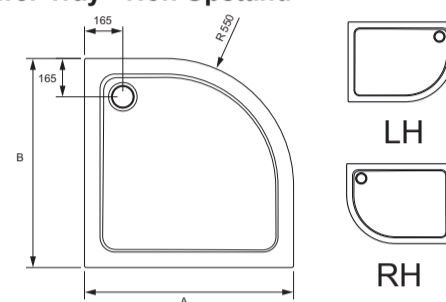

A	B	C	D	Legs
800	800	25	16	9
900	900	25	14	9
1000	1000	25	12	9
900	1200	25	9	11
1000	1000	25	12	9

Upstand Tray

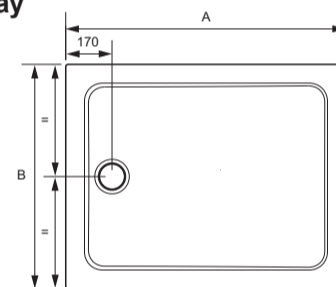

Side Profile of Upstand Tray



A	B	C	D	Legs
770	770	25	17	9
810	810	25	14	9
910	770	25	14	9
910	910	25	14	9
1010	810	25	12	9
1010	770	25	12	9
1210	770	25	9	11
1210	810	25	9	11
1210	910	25	9	11
1410	810	25	6	13
1410	910	25	6	13
1710	770	25	6	13
1710	910	25	6	13

All Dimensions in mm

CE 13

Kohler Mira Limited, Cromwell Road, Cheltenham, Gloucestershire, GL52 5EP, UK

Mira
Flight Low Shower Tray
Declaration of Performance: CE 0069
EN 14527 - CL1 + CL2

If you need a copy of the Declaration of Performance, then please contact Customer Services

CUSTOMER SERVICE

Guarantee

Your product has the benefit of our manufacture's 10 year guarantee (5 years for any commercial installations) which starts from date of purchase. Note wastes, upstand kits and riser kits are guaranteed for 1 year only.

To activate this guarantee, please return your completed registration card, visit our website or free phone 0800 0731248 within 30 days of purchase (UK only).

Within the guarantee period we will resolve defects in materials or workmanship by either repairing the product, providing new goods and parts to you in replacement or refunding (up to but not in excess of) the original purchase price, as we may choose.

This guarantee is in addition to your statutory rights and is subject to the following conditions:

- The guarantee applies solely to the original installation under normal use and to the original purchaser only. The product must be installed and maintained in accordance with the instructions given in this user guide. The product must be inspected and issues reported before installation.
- Service must only be undertaken by us or our appointed representative. **Note!** if a service visit is required the product must be fully installed and connected to services.
- Repair under this guarantee does not extend the original expiry date. The guarantee on any replacement parts or product ends at the original expiry date.
- For trims or consumable items we reserve the right to supply replacement parts only.

The guarantee does not cover:

- Call out charges for damage or defects caused by incorrect installation, frost damage, mildew, limescale, corrosion, lack of maintenance, improper use, inappropriate cleaning (please refer to our Care and Maintenance Instructions) or where no fault has been found with the product.
- Compensation for loss of use of the product or consequential loss of any kind.
- Damage or defects caused if the product is repaired or modified by persons not authorised by us or our appointed representative.
- Wear and tear.
- Accidental or wilful damage.
- Products purchased ex-showroom display.
- Costs of removal of the product following installation and/or reinstallation of any replacement product (or part) including without limitation, tiling costs.

IMPORTANT! TRAYS MUST BE INSPECTED FOR DEFECTS AND/OR DISTORTION PRIOR TO INSTALLATION. THIS GUARANTEE DOES NOT COVER THE COSTS OF REMOVAL AND/OR REINSTALLATION WHERE A DEFECT WOULD HAVE BEEN DISCOVERED BY INSPECTION PRIOR TO INSTALLATION.

What to do if something goes wrong

If your product does not function correctly when you first use it, contact your installer to check that it is installed in accordance with the instructions in this manual.

If this does not resolve the issue, contact us for help and advice.



Helpdesk Service - Contact our Customer Services Team for product advice, to purchase spare parts or accessories or to set up service visit. We will need you to have your model name or number and date of purchase.



Mira Showers Website (www.mirashowers.co.uk)

Visit our website to register your guarantee, download user guides, diagnose faults, purchase our full range of accessories and popular spares, or request a service visit.



Spares and Accessories - We hold the largest stocks of genuine Mira spares and accessories. Contact us for a price or visit our website to purchase items from our accessory range and popular spares.

To Contact Us: UK



0844 571 5000



Fax: 01 242 282595



E-mail: Visit www.mirashowers.co.uk/contactus



Mira Customer Services Dept, Cromwell Road, Cheltenham, Gloucestershire, GL52 5EP

To Contact Us: Eire Only



01 531 9337



E-mail: CustomerServiceEire@mirashowers.com

Mira is a registered trade mark of Kohler Mira Limited.

The company reserves the right to alter product specifications without notice.