

# CEDRAL

Timelessly beautiful facades

✓ *low maintenance*

✓ *factory applied  
colour*

✓ *easy to install*



## Fixing guide

April 2016

# Cedral Lap and Cedral Click

The ideal, low maintenance, rot-free alternative to traditional cladding. With the visual appeal of natural timber, simplicity of installation and resistance to rot, Cedral is an attractive, low maintenance alternative to PVCu and timber.





## Contents

- 4 Product features
- 5 Cedral Lap and Cedral Click
- 6 Dimensions and properties
- 7 System principle
- 8 Colours
- 10 Storage and handling
- 12 General fixing information
- 18 Installing Cedral Lap
- 42 Installing Cedral Click
- 54 Vertical installation
- 71 Preventing efflorescence

## Product features

- ✓ Choice of two applications within the range (Lap and Click)
- ✓ Resistant to rot, immune to attack by pests and insects
- ✓ Stands up to the harshest weather conditions
- ✓ Low maintenance
- ✓ Easy to install
- ✓ Factory applied colour
- ✓ Range of complementary aluminium trims available
- ✓ Use in the same way as wood
- ✓ Class 0 and EN 13501-1 fire performance classified to A2-s1, d0 limited combustibility
- ✓ Ideal for use where traditional timber boards might be used, especially for facades and window and door surrounds
- ✓ Can achieve an A+ rating in the BRE's Green Guide to Specification\*
- ✓ BBA Certificate No. 06/4299

\* Based on generic rating for autoclaved fibre cement (calcium silicate) cladding (Element ref. 806220701, 806220675, 806220676).



## Cedral Lap

Ideal low maintenance, rot free alternative to traditional timber. Fitted in traditional lapped style and with the visual appeal of natural timber, Cedral is an attractive, low maintenance alternative to all types of weatherboarding.



## Cedral Click

Cedral Click is the UK's first flush fitting, fibre cement, tongue and groove cladding board.

With the same performance benefits and textured surface finish as Cedral Lap, Cedral Click is supplied with a simple 'Click Clip System', which makes installation quick and easy.



Dimensions		
	<b>Cedral Lap</b>	<b>Cedral Click</b>
Length	3600mm	3600mm
Width	190mm	186mm
Thickness	10mm	12mm
Weight per board	11.2kg	12.2kg

Properties (air dry)		
	<b>Cedral Lap</b>	<b>Cedral Click</b>
Installed weight	19.3kg/m <sup>2</sup>	17.8kg/m <sup>2</sup>
Density	1300kg/m <sup>3</sup>	1300kg/m <sup>3</sup>
Bending strength:		
Longitudinal	23N/mm <sup>2</sup>	23N/mm <sup>2</sup>
Transverse	11N/mm <sup>2</sup>	11N/mm <sup>2</sup>
Modulus of elasticity:		
Longitudinal	7500N/mm <sup>2</sup>	7500N/mm <sup>2</sup>
Transverse	5500N/mm <sup>2</sup>	5500N/mm <sup>2</sup>
Expansion from dry air to saturated	1.75mm/m	1.75mm/m
Thermal conductivity	0.212W/mK	0.212W/mK
Reaction to fire:		
Building Regulations	Class 0	Class 0
EN 13501-1	A2-s1, d0	A2-s1, d0

## System principle: ventilated rainscreen

Cedral Lap and Cedral Click are installed to the ventilated rainscreen principle. This means air can flow in at the base of the system, behind the cladding and then out, over the top of the Cedral weatherboard system.

A minimum 30mm ventilation gap must be left behind the boards with a minimum 10mm continuous gap left at the top and bottom of the system for full circulation.

The air flow behind the Cedral weatherboard enables the system to remove moisture. Impeding this process could lead to moisture problems within the system.

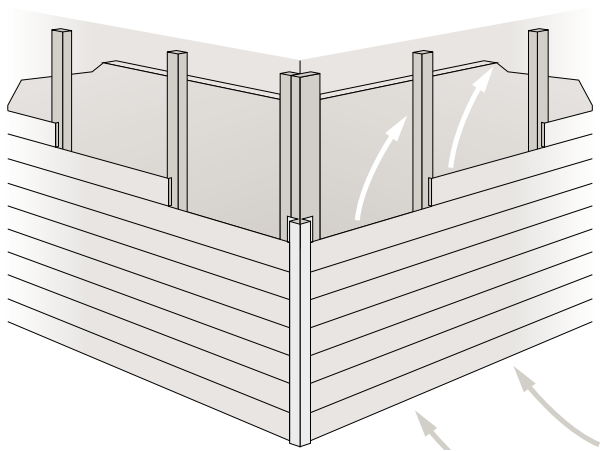

## Earth tones

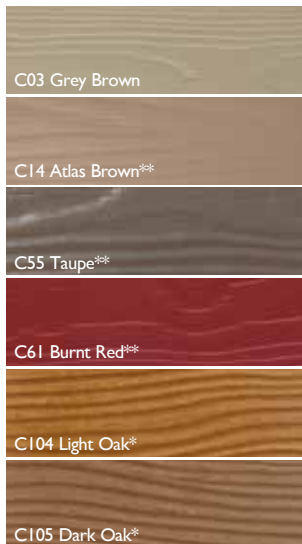

## Forest tones



## Woodstains

Cedral Lap is available in 2 woodstain shades designed to mimic the appearance of stained natural wood finish and as such, a variation in colour and shade is part of the effect inherent in the material design. The translucent finish will be accentuated by the effects of ambient light and viewing angle.

Due to transparent coating, it is not recommended to install Cedral Lap woodstain colours vertically.

## Touch up paint

Cedral touch up paint is available in 0.5 litre quantities for all colours except woodstain shades. This should be used sparingly only where there is damage to paint or on cut edges. For woodstain shades, use a close matching colour on the cut edges to protect against edge staining post installation.



## Mineral tones



## Ocean tones



## Availability

All painted colours are available in a smooth finish for Cedral Lap and Cedral Click (subject to extended lead times).

Bespoke colours are subject to minimum order quantities and extended lead times.

## Aluminium trims

Supplied in colours to match and complement the Cedral range.

\* Not available in Cedral Click, Cedral Click Smooth or Cedral Lap Smooth.

\*\* Cedral Click in the colours identified may be subject to minimum order quantities and extended lead times.

# Storage and handling

## Storage

Cedral should be stored under cover on the pallets on which they are supplied. Any temporary transportation hoods should be removed to release any trapped moisture and the pack re-covered with an opaque tarpaulin.

The planks should be protected from mud staining.

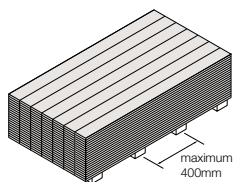

Ensure sufficient bearers, stack on a level surface and never stack against a wall

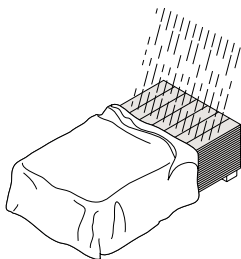

Must be protected from the weather

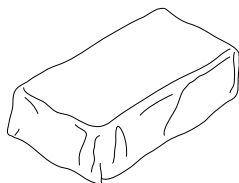

Store under cover, ideally inside

## Handling

Care should be taken at all times when handling Cedral on the flat, as it can break. While Cedral is stored on the flat, it should be fully supported along its full length on purpose designed pallets. Manual handling is best carried out with the planks carried on their sides. When a single person is carrying a plank, it should be turned on to its side before being lifted off the stack, and then the handler must keep their hands as far apart as possible to provide maximum support for the board.

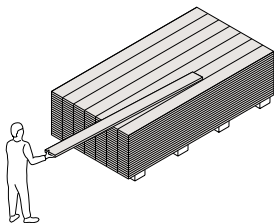

Do not drag planks off the stack

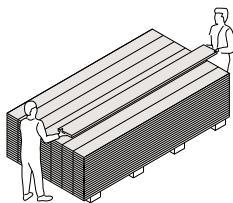

Planks must be lifted off the stack

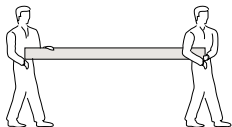

Carry on edge but do not store on edge

# GENERAL FIXING INFORMATION

- 13 Cutting
- 14 Screwing
- 14 Nailing
- 16 Health and safety
- 16 Wind loading
- 17 Surface mounted features
- 17 Ventilation

# Cutting

The method of cutting is dependent on the amount there is to be done. It is possible to cut the board with a handsaw, guillotine, electric jigsaw or circular saw.

After cutting, wipe away dust with a clean, dry cloth.

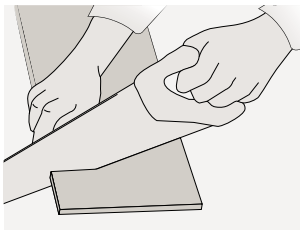

Note: Cutting and drilling must take place in a dry and well ventilated environment.

## Handsaw

This method requires a hardened point saw and is recommended for small amounts of cutting.

## Guillotine

Cedral can be cut with a specially manufactured guillotine.

## Electric jigsaw

Turning Cedral over and cutting on the reverse will ensure a clean finish on the front of the plank.

## Hand held circular saw

A hand held circular saw with fibre cement blades is ideal for cutting large quantities. These are available from local suppliers.

## A diamond-dusted blade

Used with a tungsten tipped blade of 36 teeth on a 180mm diameter blade is recommended for cutting. Also with this method, cutting from the back of the board is advisable as the saw guide leaves marks across the board surface. Test cutting is recommended.

## Screwing (recommended)

Screw fixing to the support structure is recommended and can be achieved without pre-drilling where fixings are at least 50mm from the end of the board (screw gun required). Where screws are to be within 50mm of the end of the board then a pre-drilled hole and countersink is required to suit the screw size. Screws must be stainless steel min. size 4.0 x 45mm.

The following minimum distances from the edge to the screw and nail must be respected.

### Edge distance

D1	20mm
D2	20mm

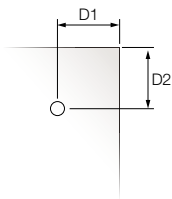

## Nailing

### By hand

The board can be hand nailed without pre-drilling when the nails are at least 50mm from the end of the board. For nails closer than 50mm to the end, nail positions need pre-drilling with a 3mm drill bit. Normal HSS drill bits can be used but they will need regular sharpening. Nails should be stainless steel ring shank, minimum size 2.8 x 45mm with 7-10mm head.

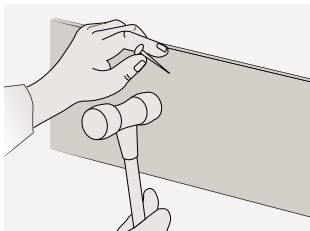

## Pneumatic nailing

Cedral can be pneumatically nailed. There is a large selection of guns on the market. Stainless steel fixing is a must, as they last as long as the board. The nail length should be 50mm and be 2.8mm dia. A ring shank nail is preferred and has a full round

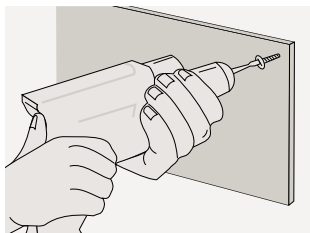

head of 7mm dia. The type of gun nail which has a narrow head (The nail looks more like a “T” section) is not acceptable. Nails with a “C” shaped head are acceptable but should be minimum 7mm-dia head.

Trial nailing should be conducted to set the depth of the fixing, and how close to the edge of the board nails can be placed.

Any pneumatic gun which is being considered, must be adjustable otherwise the nails could either be fired right through the board or left proud of the face of the board (check with manufacturer).

Nails should be flush with the board face.

## Health & safety

Dust can be released while the sheets are being processed which can irritate airways and eyes. Long-term exposure to dust can be harmful to health. For more information, please refer to the safety data sheet which can be found in the technical section for Cedral Lap at [www.cedral.co.uk](http://www.cedral.co.uk).

## High wind loading or exceptional impact requirements

Should wind loading exceed  $1.0\text{kN/m}^2$  please consult the Technical Department (01283 722588). Where exceptional impact loads to the Cedral planks can be anticipated (i.e. low level applications near pedestrian access, schools, leisure facilities etc.) additional timber battens should be incorporated, between the fixing battens, to increase the plank resistance.

## Surface mounted features

Where other building features (i.e. signs, gutters, canopies etc.) are to be fixed then additional batten work should be included and clearance holes must be provided through Cedral. Under no circumstances should the Cedral planks receive additional structural loads.





## Ventilation

To avoid interstitial condensation, a minimum 30mm free flow cavity should be provided behind the Cedral with a minimum 10,000mm<sup>2</sup>/m run of ventilation at the top and bottom of the installation.

The use of 38mm deep battens will provide the necessary cavity and will be of minimum sufficiency to resist the pull-out loads generated by the planks.

# INSTALLING CEDRAL LAP

- 19 Introduction
- 20 Batten fixing
- 21 Attach perforated closures
- 23 Vertical profiles
- 27 Horizontal starter profiles
- 29 Installation
- 35 Corner options
- 39 Finishing and decoration
- 40 Additional insulation





There are a number of fixing variants for Cedral, but the general principle is the same for all.

Cedral needs to be fixed to vertical timber battens (preservative treated and planed on two faces) of at least 50mm wide, spaced at a maximum of 600mm across the elevation. Cedral should be fixed to at least three battens: if it is only fixed to two, then the batten spacing should be reduced to 400mm.

A minimum 30mm clear cavity must be provided behind Cedral with a 10mm continuous opening at the base, head and at the window and door heads and cills.

## 7 step installation procedure

1. Fix battens to wall
2. Attach perforated closures to top and bottom of battens
3. Fix vertical profiles
4. Fix horizontal starter profiles
5. Cut and fix Cedral Lap planks
6. Corner options
7. Finishing and decoration

## Position and fix the vertical battens\*

Battens to be spaced a maximum of 600mm apart (reduce this in high windload areas).

### Batten sizes

- Standard fixing – 50mm x 38mm
- Joints/corners – 75mm x 38mm

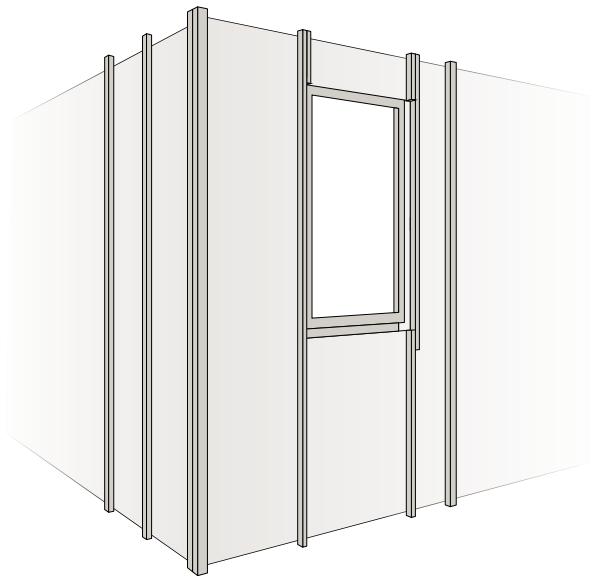

\* For solid walls, timber frame and metal stud constructions it is good practice to include a breathable membrane behind the battens. Generally for unfilled/partially filled cavity walls there is no requirement to do this.

## Perforated closures

Aluminium finish 2.5m length.

Perforated closures should be screwed or nailed to both the top and bottom of battens. They are designed to protect against birds, rodents and some insects while still allowing air to flow through the system.

Available in depths of 40mm, 50mm, 70mm and 100mm to allow for coverage of external insulation.

Perforated closures should also be attached to each door, cill and window head, to prevent animal and insect ingress whilst allowing ventilation paths to be maintained.



Perforated closure

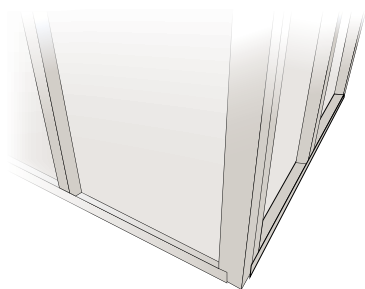

## Base of cladding

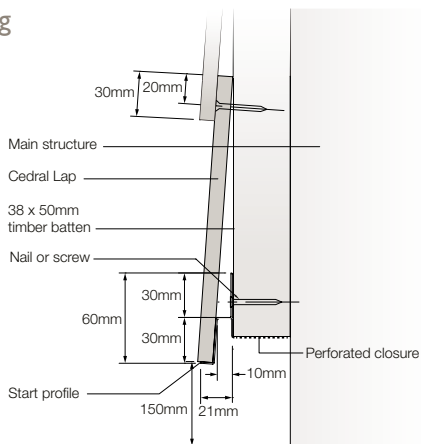

## Plinth detail

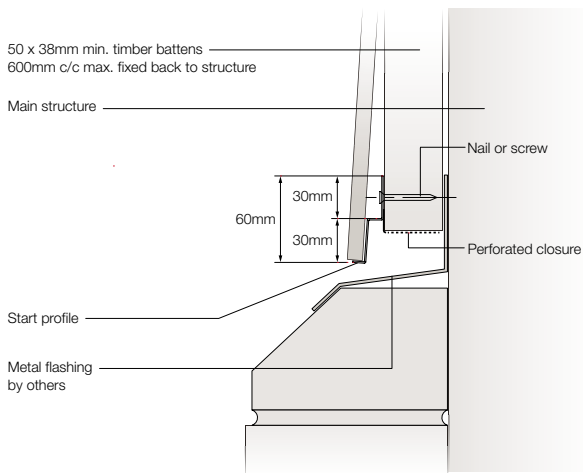

Cedral trims are manufactured to meet the required safety standards and have a guaranteed level of quality. They are colour matched to Cedral planks and branded on the reverse for easy identification.



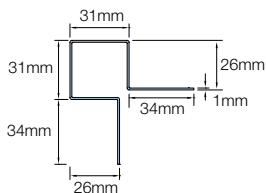

### External corner (symmetric)

This universal trim can be used to provide protection on external corners and for stop profile applications.

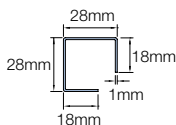

### External corner junction

Used as a corner joining piece. Only available in black. 300mm length.

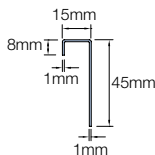

### Connection profile

End trim to finish Cedral when used as a single piece on a window reveal or soffit.

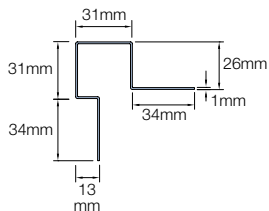

### External corner/window reveal (asymmetric)

Used as an external corner on window reveals where detailing on a reveal is a single piece.

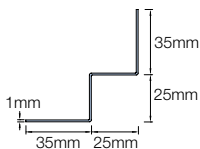

### Internal corner

To finish the corner where Cedral meets an internal corner forming a seal between the trim and the corner.

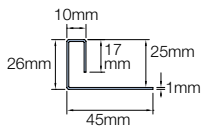

### End profile

To finish Cedral where installed in a lap configuration.



## Fix vertical profiles

Position, level then screw or nail end profiles, corner profiles and window profiles into place.

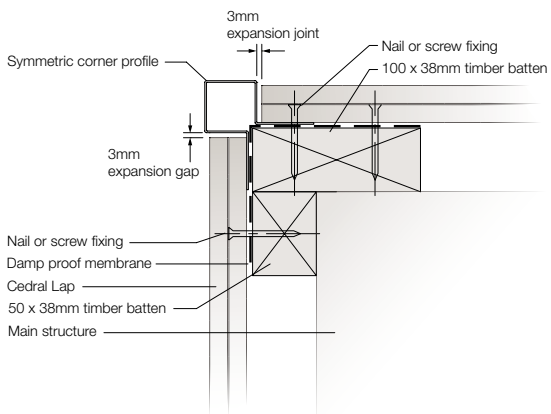
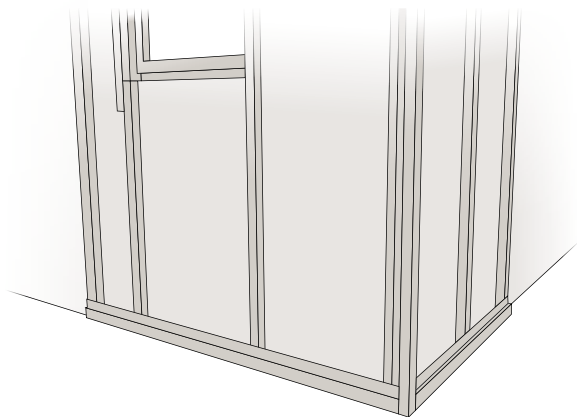

## Fix vertical profiles

Fix external window (asymmetric) profiles to the sides of the window.

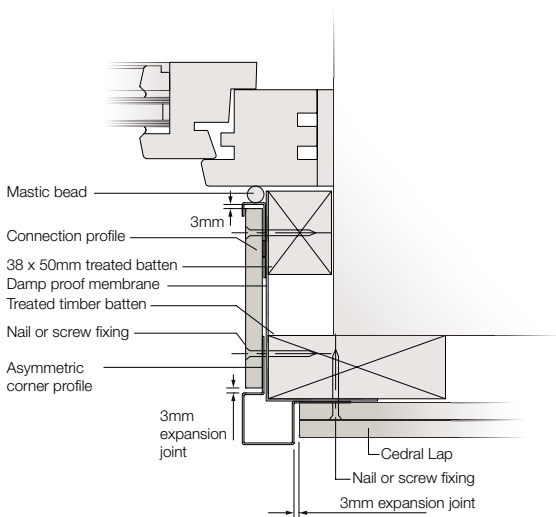
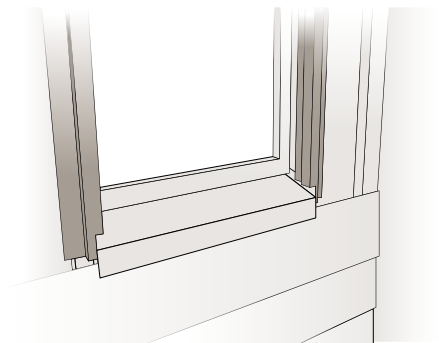

## Horizontal profiles

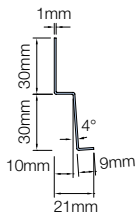

### Start profile

Used to start a cladding run with a lip to cover the first batten.

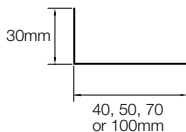

### Perforated closure

Designed to protect against vermin and some insects while still allowing air to flow through the system.



## Fix horizontal starter profiles

Ensure starter profile is level then screw or nail into place. The starter profile will 'kick out' the first plank to ensure the look is uniform with the rest of the installation.

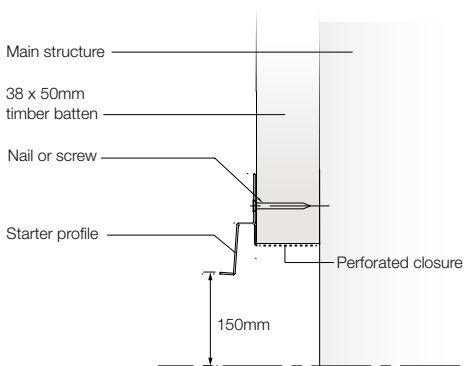

## Choose your horizontal laying pattern

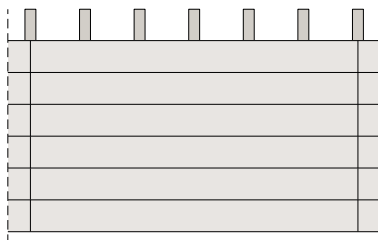

Straight or butt jointed

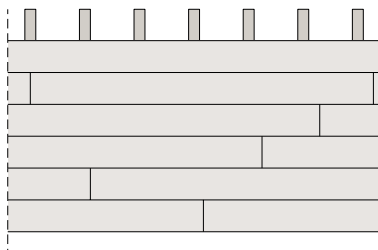

Free pattern

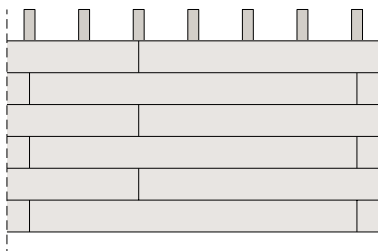

Semi pattern or broken bond

## Start installation

Place the first Cedral plank onto the starter profile. Ensure that the plank is fixed to every batten it crosses. The end of every plank must also coincide with a batten.

Lengths of over 400mm must be fixed to at least 3 battens.

Fixings must be a minimum of 20mm from the edges of the Cedral plank:

### Edge distance

D1	20mm
D2	20mm

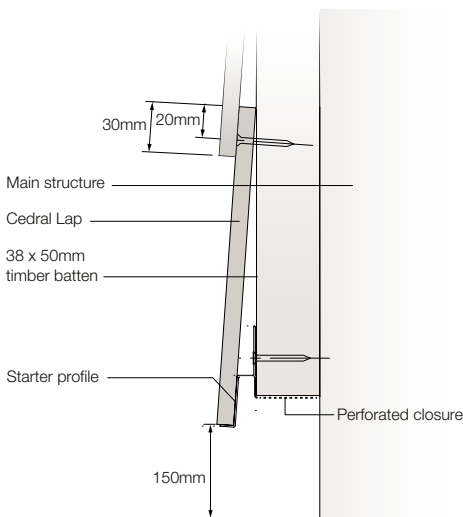
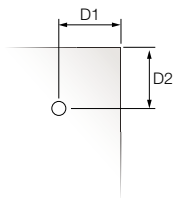

## Cedral installation

Overlap the next plank by 30mm, fix into place then continue fixing Cedral up the wall using the same method.

Each plank must be fixed at least once to every support. The end of every plank must also coincide with a support. Where specified, install vapour barrier or breather membrane over the wall or framework behind the timber studs.

Allow at least 150mm between bottom edge of Cedral and the ground. Fixing is done through the upper edges. There is no side overlap, the planks being simply loose butt jointed against one another, and the joint must coincide with a timber support.

A strip of black polyethylene soaker should be applied under the vertical joints to protect the batten.

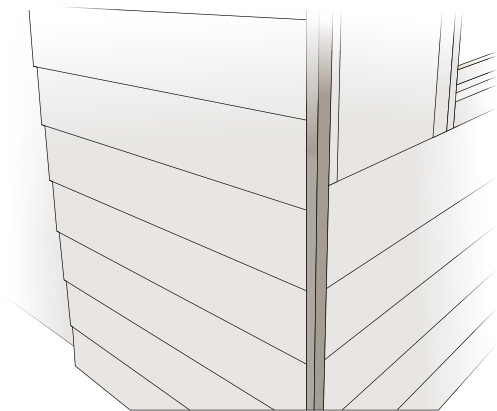

## Jointing of Cedral

When two planks of Cedral are joined together and fixed to one batten, a protective strip should be placed onto the batten to guard against moisture ingress.

Planks should be loose butt jointed together, do not use force.



## Finishing Cedral at top of wall

When you get to the top plank, the fixings will remain visible. For best results use colour matched Cedral board screws.

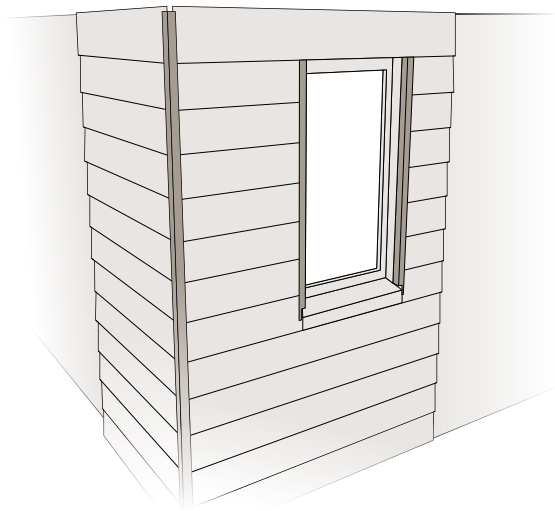



## Soffit detail

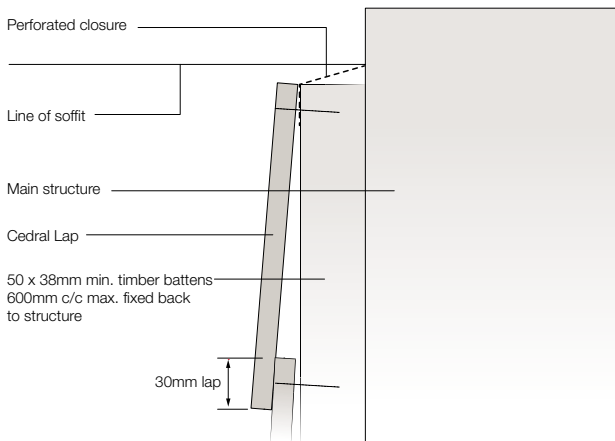

## Sloping soffit detail

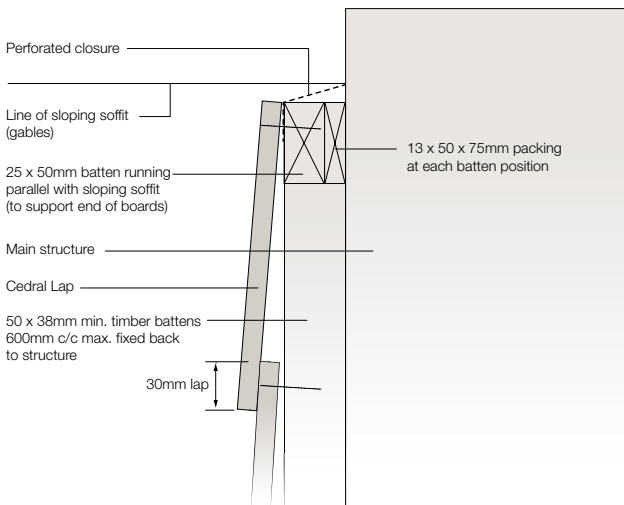

## Finishing Cedral at top of wall: abutments and gables

Where Cedral abuts another material and when no end trims are required, the end of Cedral must not be more than 100mm past the last fixing point.

On the gable ends with the triangular abutment, Cedral needs to be fixed top and bottom to the batten that is parallel to the roof slope. If the bottom edge is not secured, curling can occur in certain conditions.

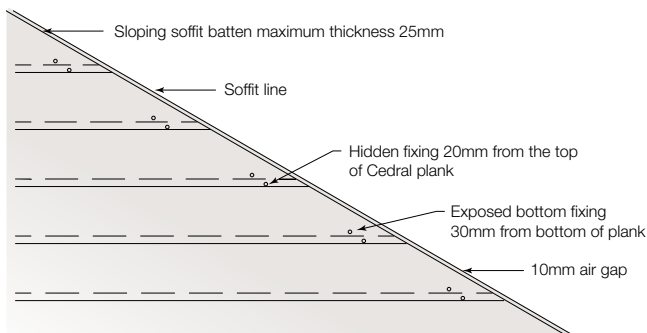

## Corner options

There are a number of ways of finishing both external and internal corners using Cedral.

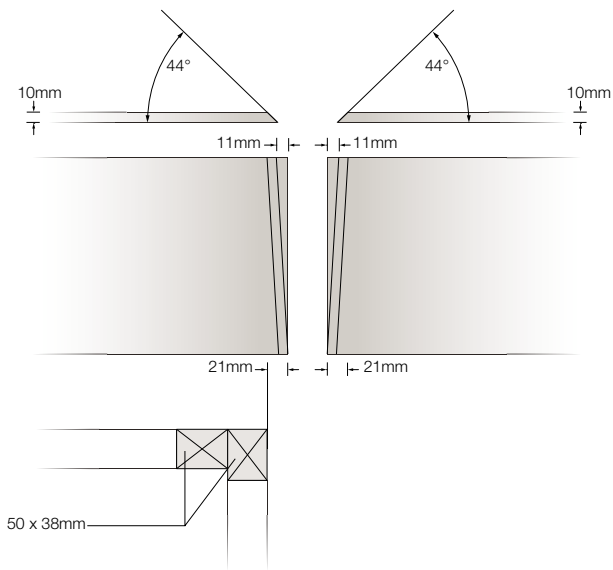

## Overlapping corner

This is when the board of one side overlaps the end of the plank on the other side. There will always be one end of plank showing with this method. These ends need to be decorated to match the finish on Cedral. The transverse cuts of the plank at the corner positions will not be perpendicular with the sides of the boards.

## Mitred corner

To form the mitre the planks have to be cut 23mm longer on the bottom edge, 13mm longer on the top edge than the dimension to the corner of the support battens. This cut is also cut at an angle of  $44^\circ$  through the thickness of the plank (we suggest marking the plank at  $45^\circ$  and under-cut). The above only works on a true  $90^\circ$  corner, other corner angles will be by trial and error.

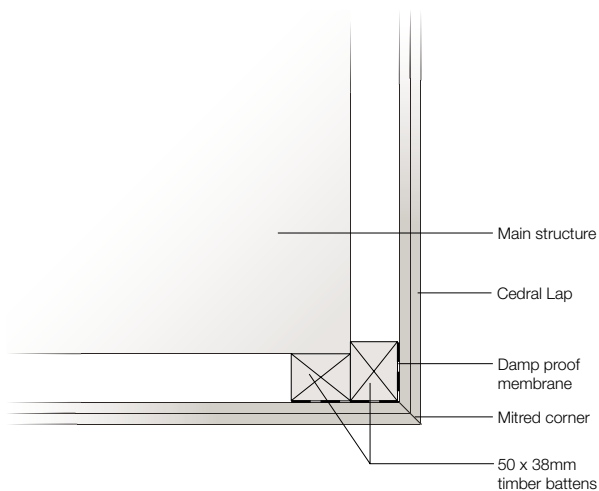

## External corner detail

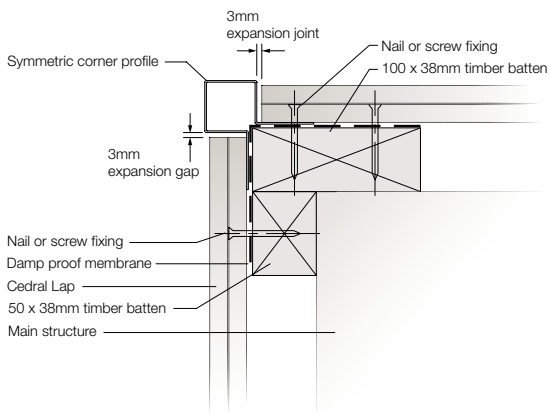

## Internal corner detail

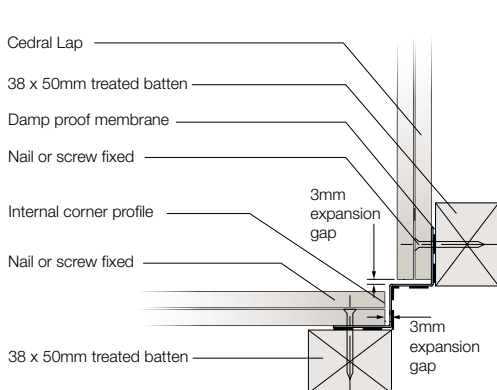

## Corner/abutment with end profile

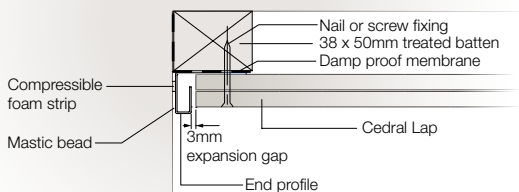



## Finishing and decoration

Touch up paint is available in all colours of Cedral except woodstain shades. This should be used sparingly, only where there is damage to paint or on cut edges.

For woodstain shades, lightly coat the cut edges with closely colour matched touch up paint to protect against edge staining post installation.

## Additional insulation

Should insulation be required, additional cavity depth can be gained with the use of cross battens or adjustable brackets.

### Securely fix horizontal battens on wall/substrate\*

These will accommodate any insulation required and also support the vertical battens to which the Cedral planks will be fixed.

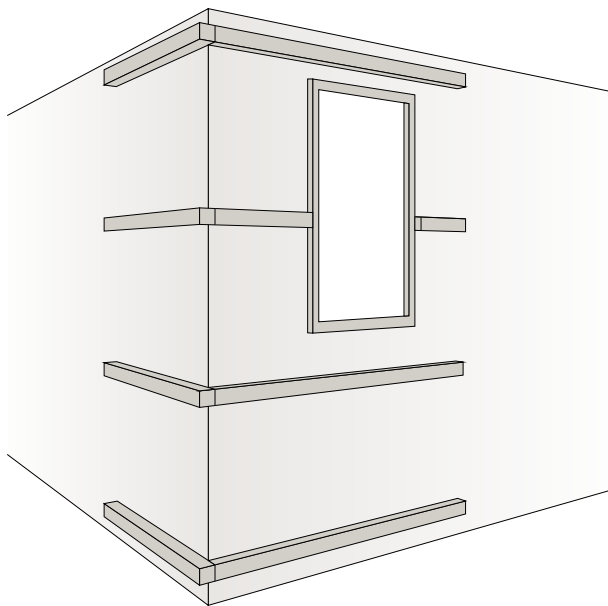

\* For solid walls, timber frame and metal stud constructions it is good practice to include a breathable membrane behind the battens. Generally for unfilled/partially filled cavity walls there is no requirement to do this.



## Fix insulation to the wall between the battens or angle brackets

Make sure there are no gaps. Alternatively, use adjustable wall brackets to fix battens if greater thickness of insulation is required. Vertical battens will then be fitted on top of the horizontal battens.

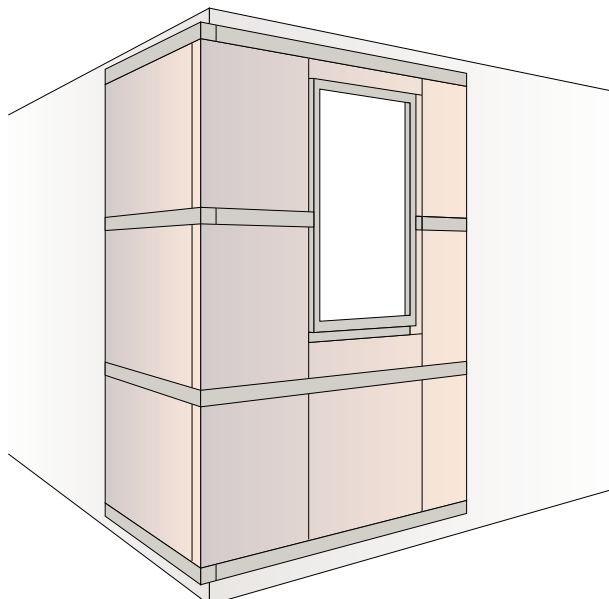

Adjustable wall bracket

# INSTALLING CEDRAL CLICK

- 43 Introduction
- 44 Batten fixing
- 45 Attach perforated closures
- 46 Fix vertical profiles
- 47 Fix horizontal profiles
- 48 Installation

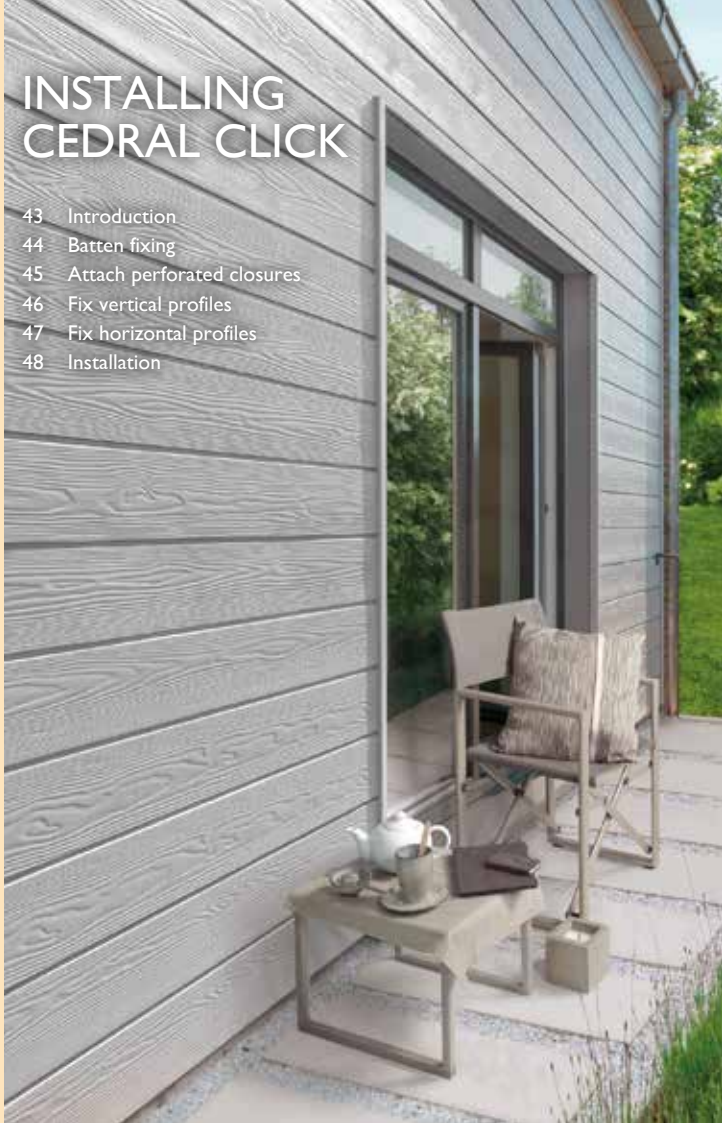



## 5 step installation procedure

1. Fix battens to wall
2. Attach perforated closures to top and bottom of battens
3. Fix vertical profiles and horizontal (starter) profiles
4. Cut and fix Cedral Click planks
5. Other detailing

## Fix battens

Position and fix the vertical battens. Battens to be spaced a maximum of 600mm apart (reduce this in high windload areas).

### Batten sizes

- Standard fixing – 75mm x 38mm
- Joints/Corners – 100mm x 38mm

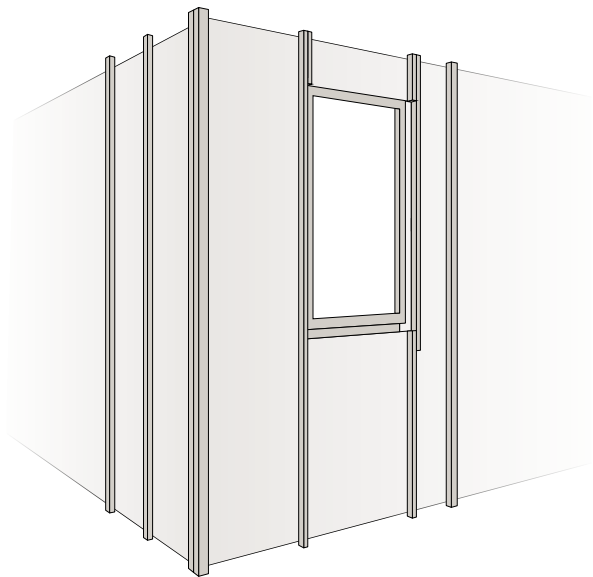

## Attach perforated closures

Perforated closures should be screwed or nailed to the top and bottom of battens for each door, cill and window head.

They are designed to protect against birds, rodents and some insects while still allowing air to flow through the system.

Available in depths of 40mm, 50mm, 70mm and 100mm to allow for coverage of external insulation.

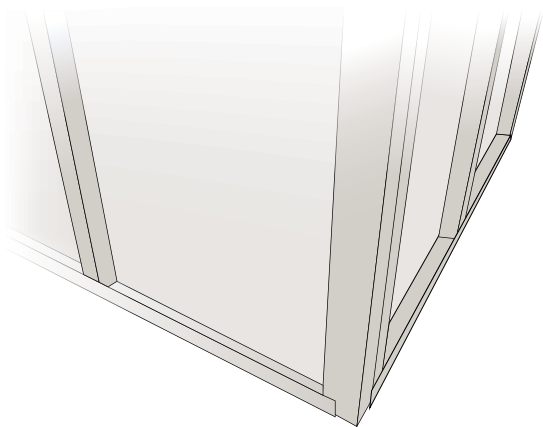

Perforated closure

## Fix vertical profiles

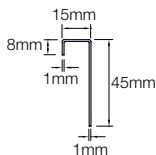
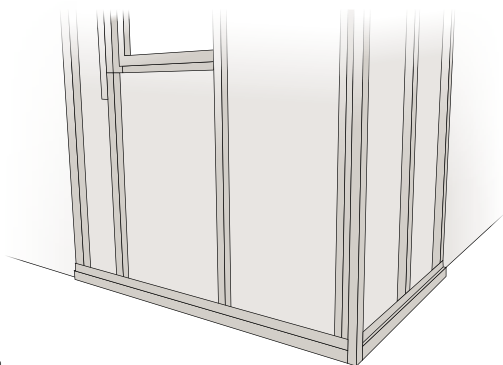

### Connection profile

End trim to finish Cedral when used as a single piece on a window reveal or soffit.

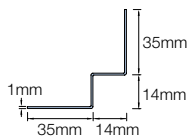

### Internal corner

To finish the corner where Cedral meets on an internal corner forming a seal between the trim and the corner.

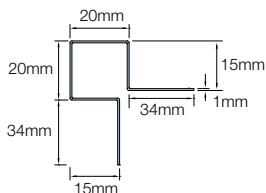

### External corner/ window reveal

Can be used as an external corner or where detailing on a window reveal.

## Fix horizontal profiles

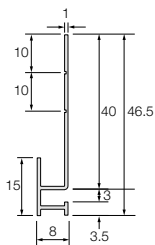

### Starter profile

Used at base of the external wall. Installed absolutely level to ensure installation of Cedral Click panels remains perfectly parallel.

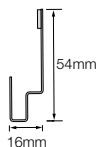

### Window lintel profile

Used to finish above the window and to support the next course of Cedral Click.



## Installing Cedral Click

All fixing will be achieved with Click clips.

These are fixed with stainless steel mushroom-head screws onto timber or with rivets onto metal frame.

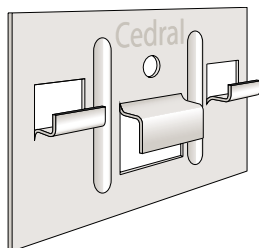

### Fixing clip and special screw fixing

Clip and screw are made of stainless steel 304 (A2).

The clip dimensions are: 60 x 40mm with hooks matched to the Cedral Click requirements.

The screw has the following dimensions: 3.9 x 30mm with screw head suited for fastening the clip. This means a flat head with a partially flat lower side.





## Base of wall

A minimum 30mm clear cavity must be provided behind the Cedral Click planks with a 10mm opening at the base, head and at the window, door and cills. Assembly starts at the bottom of the outside wall with the purpose designed Cedral Click plank start profile. The start profile must be perfectly level. Use appropriate countersunk head screws so the screw head does not block the placement of the first Cedral Click plank. The first Cedral Click plank is then fitted on to the start profile and fixed with clips on every support. Then the next Cedral Click plank is put on the first one.

The plank will then be fixed with the use of Click clips, these will be placed on every batten.

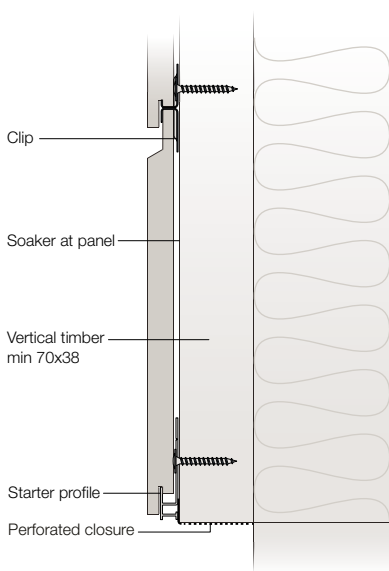

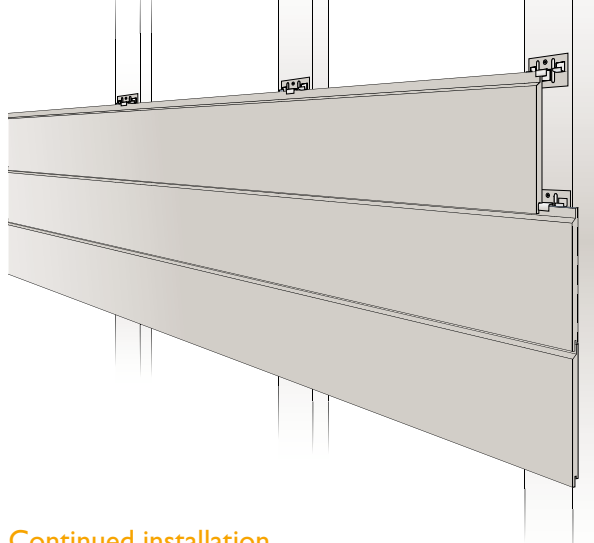

## Continued installation

The Cedral Click planks are placed with the ends against each other and always on top of an underlying supporting batten.

Not only behind the joints, but the entire wooden supporting battens are protected by a joint sealing strip with sufficient stiffness. Because the joint sealing strip is not exposed to light, a black polyethylene (PE) 0.5 mm-thick joint sealing strip is sufficient. If the joint sealing strip is exposed to light, a UV-resistant material such as EPDM must be used.

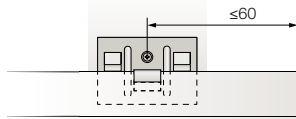
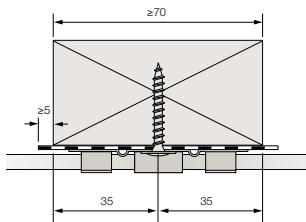

The distance from the edge of the Click Clip to the edge of the Cedral plank should not exceed 60mm

## Window detailing and external corner

The vertical reveal sides of a window can be finished with the Cedral Click external corner profile. At the window head, the lintel profile can be used. This lintel profile can be used with whole Cedral Click planks or with cut planks. Holes in the lower part of the back of the profile prevent water pooling in the profile.

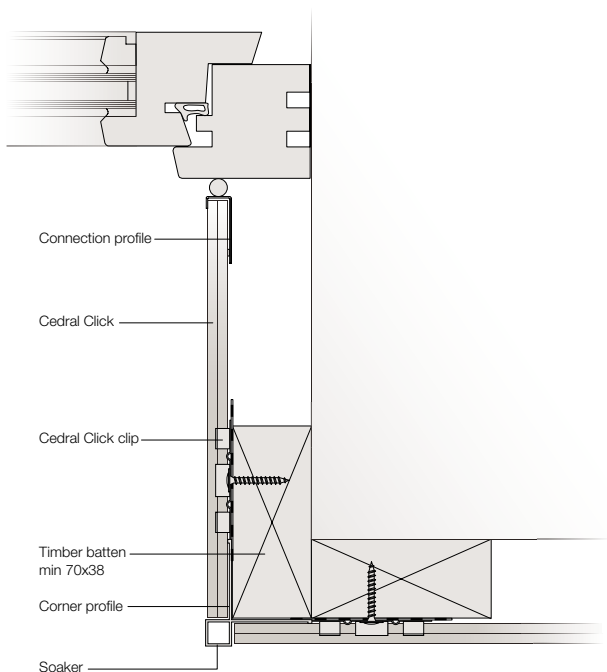

## Internal corner

To finish an internal corner, use Cedral Click internal corner profile which forms a seal between the trim and the corner.

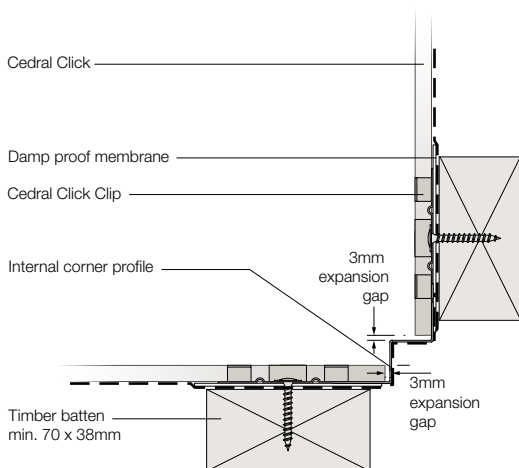

## Fixing the last Cedral Click plank

At the top of the facade there are two options for fixing the last Cedral Click plank:

- If the facade finishes with a whole Cedral Click plank it can be fixed with clips.
- If the facade finishes requiring a trimmed Cedral Click plank it should be fixed with coloured mushroom head screws.

The screws must be inserted perpendicular to the panel surface using an electric drill with a high quality bit suitable for the type of screw head.

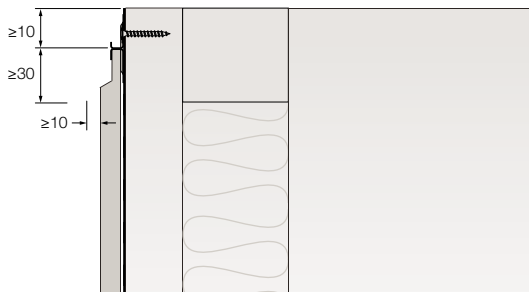
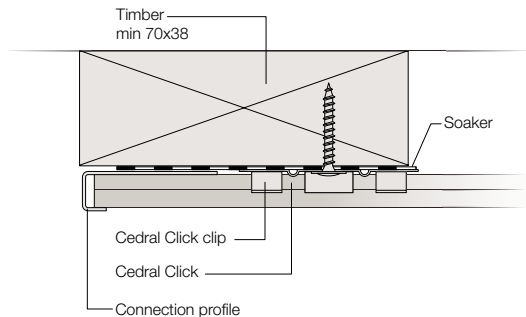

# VERTICAL INSTALLATION OF CEDRAL

- 55 Introduction
- 56 Lay of planks
- 57 Install timber battens
- 58 Fix perforated closures
- 59 Fix profiles
- 65 Fixings
- 66 Installation



## Ventilated rainscreen system

A ventilated rainscreen cladding system must be fixed onto battens to allow an air gap behind the cladding.

With a traditional horizontal installation of Cedral only vertical battens would be needed.

To install Cedral vertically, vertical battens must be installed first, with horizontal counter battens then placed on top. This allows the air gap behind the cladding while giving a fixing point.

Please note: A minimum air gap of 10mm must be left at the top and bottom of all sections to allow air to flow completely through the system.

### Horizontal

Passage  
of air

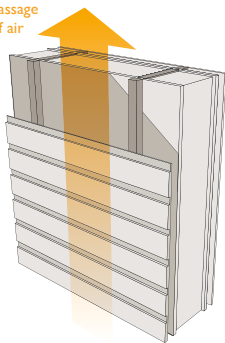

### Vertical

Passage  
of air

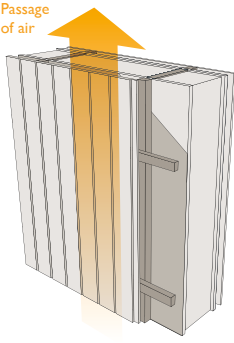

## 5 step installation procedure

1. Decide on the 'lay' of the Cedral planks
2. Install timber battens
3. Fix perforated closures
4. Fix profiles
5. Install Cedral planks

## Decide on the lay of the planks

Cedral can be installed vertically using one of 4 different options:

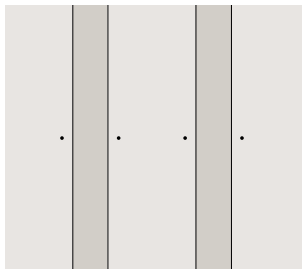

### Undulating

Planks are laid in an “over under over” pattern. The fixings remain visible.

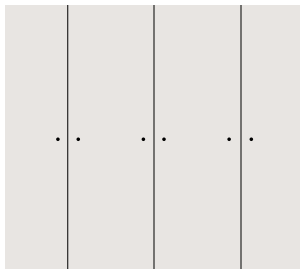

### Flat

Planks are laid next to each other, either loosely butted or with up to a 2mm gap. Fixings remain visible.

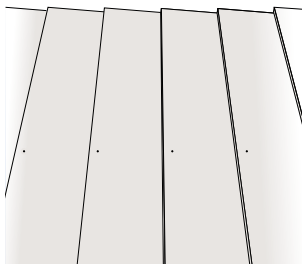

### Lapped

Planks are overlapped by 30mm. Fixings will remain visible.

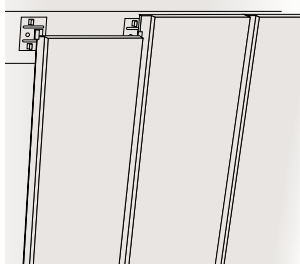

### Cedral Click

Cedral Click planks are used in conjunction with Click Clips. This is a tongue and groove system where all fixings are hidden apart from the fixings on the starter and final boards.



## Install timber battens

Vertical battens must be placed first. These must be a minimum size of 25mm x 50mm and spaced at a maximum 600mm.

Adjustable wall brackets can be used instead of vertical timber battens.

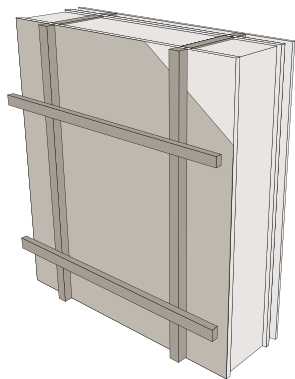
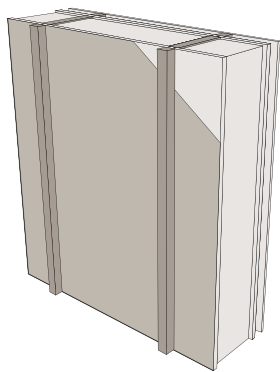

Horizontal counter battens should then be fixed.

These must be a minimum size of 38 x 50mm and spaced at a maximum 600mm. They should also be trapezoidal in shape to allow for water run off.

## Fix perforated closures

Fix perforated closures to the top and bottom of the vertical timber battens, including each door, cill and window head.

Perforated closures allow the flow of air while preventing birds, vermin or pests gaining access.

If using adjustable wall brackets, fix the perforated closure to the rear of the top and bottom vertical battens. Adjust the brackets to ensure the rear gap is completely closed top and bottom.



Perforated closure



## Cedral Lap profiles

When installing Cedral Lap vertically, consideration should be given to the profiles used. For further information, please contact Marley Eternit's Technical Advisory Service.

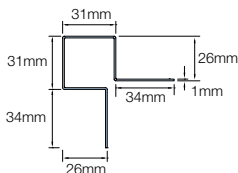

### External corner (symmetric)

This universal trim can be used to provide protection on external corners and for stop profile applications.

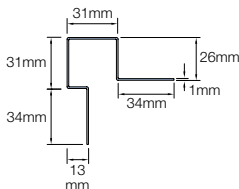

### External corner/window reveal (asymmetric)

Used as an external corner on window reveals where detailing on a reveal is a single piece.

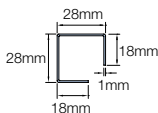

### External corner junction

Used as a corner joining piece. Only available in black. 300mm length.

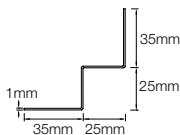

### Internal corner

To finish the corner where Cedral meets an internal corner forming a seal between the trim and the corner.

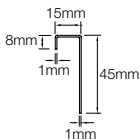

### Connection profile

End trim to finish Cedral when used as a single piece on a window reveal or soffit.

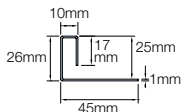

### End profile

To finish Cedral where installed in a lap configuration.

## Cedral Click profiles

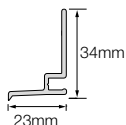

### Vertical start profile

Used to start a vertical cladding run. Installed absolutely level to ensure installation of Cedral remains perfectly vertical.

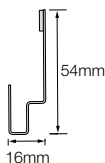

### Window lintel profile

Used to finish above the window.

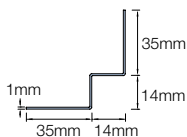

### Internal corner

To finish the corner where Cedral Click meets on an internal corner forming a seal between the trim and the corner.

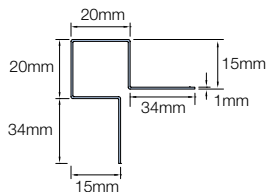

### External corner/ window reveal

Can be used as an external corner or where detailing on a window reveal.

## If using the undulating lay pattern

(Cedral Lap only)

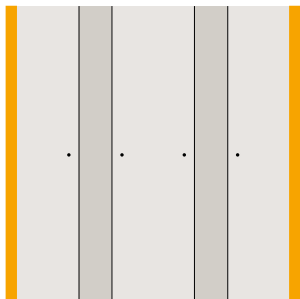

Fix vertical symmetric external corner profiles, asymmetric corner profiles, internal corner profiles or end profiles depending on the application.

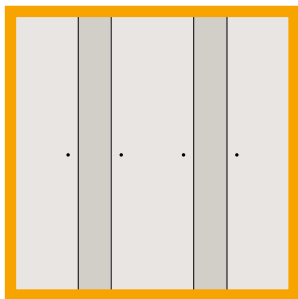

Fix end profiles horizontally at the top and bottom of each run of planks.

Please note profiles must be fixed before any Cedral planks are laid.

## If using the flat lay pattern

(Cedral Lap only)

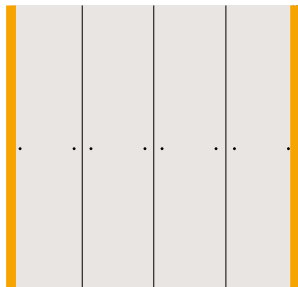

Fix vertical connection profiles, click external corner profiles or lap external corner profiles.

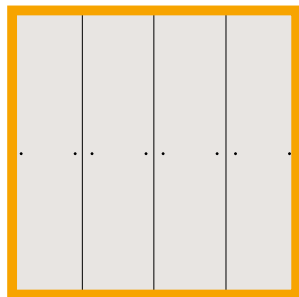

Fix horizontal connection profiles to the top and bottom of each section of planks.

## If using the lapped lay pattern

(Cedral Lap only)



Install horizontal end profiles at the top and bottom of each section of cedral planks.



Fix vertical symmetric external corner profiles, asymmetric corner profiles, internal corner profiles or end profiles depending on the application.

Fix starter profiles where required to kick the first board of each run out to make it uniform with the rest.

Please note profiles must be fixed before any Cedral planks are laid.

## If using the Cedral Click system

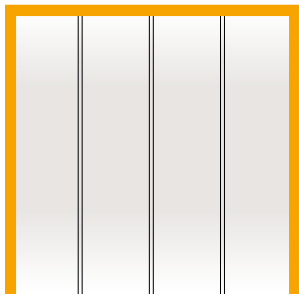

Install vertical click starter, external corner, connection and/or internal corner profiles depending on the application.



Fix vertical start profile below all Cedral Click planks to support the system.



## Cedral screws

Because fixings are visible in all vertical applications of Cedral Lap (apart from Cedral Click), the use of Cedral colour matched screws is recommended for all fixings.

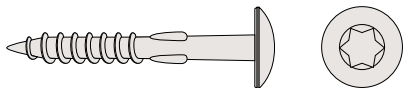

## Click Clips and screws

If installing Cedral Click vertically, the use of Click Clips is required. These are supplied complete with stainless steel screws in boxes of quantity 250.

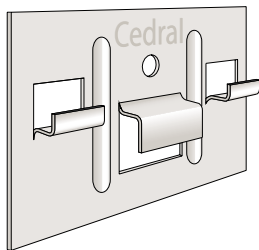

## Undulating method

Begin by placing all rear planks and spacing with a 70mm gap between each plank. Fix into place twice onto every batten every 600mm a minimum of 20mm from the edge of the plank.

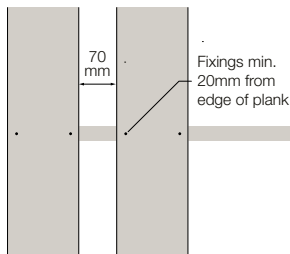

Place front planks over the rear plank ensuring the overlap is a minimum of 60mm.

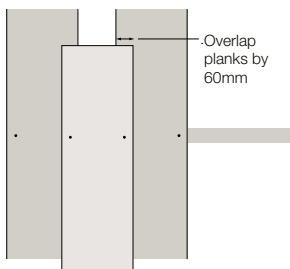

Screw through the face of the front planks penetrating both planks and screwing into the timber. Fixings must be 20mm minimum from the edge of the plank and again all planks must be fixed twice to every batten.

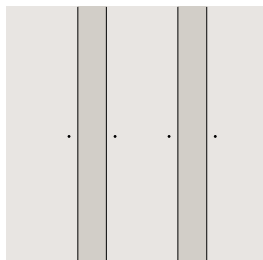

## Flat

Place the first plank then screw into place. Ensure fixings are a minimum of 20mm from the edge of the plank and the plank is fixed twice onto every batten.

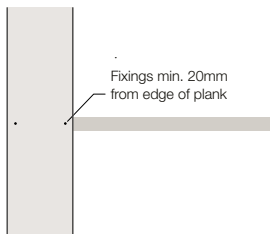

Loosely butt joint the next plank or leave a uniform gap of between 0 and 2mm between planks. Screw into place in the same way.

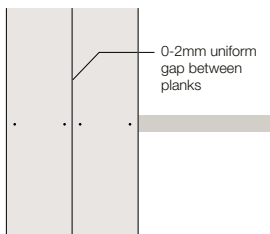

Continue to place planks and fix into place.



## Lapped

Place the first plank onto the timber fillet or tilt to give a 10mm “kick out”, then screw into place ensuring fixings are 20mm from the top edge of the plank.

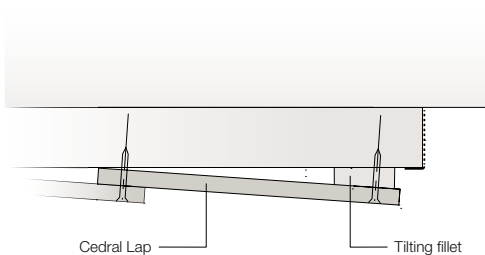

Place secondary fixings through the tail of the plank at 50mm from the edge and fixings are every 600mm (these will remain visible).

Overlap 30mm with the next plank then screw into place through both the head and the overlap to reduce water ingress.

Continue lapping and fixing planks into place until complete.

## Installing Cedral Click planks

Slot the first plank into the starter profile.

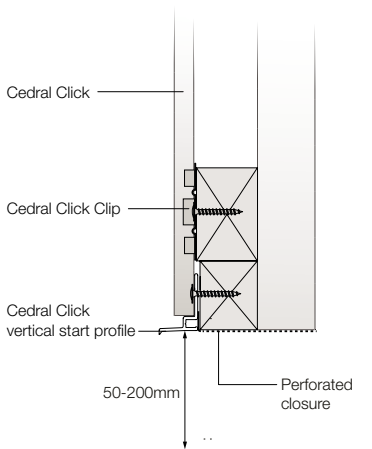

Rest the bottom of the planks on the vertical start profile.

Please note the bottom batten must be trimmed to allow this to fit correctly as per the diagram above. This must also be repeated between joints.

## Installing Cedral Click planks



Screw Click Clips onto every batten to fix the edge of the plank into place.

Slot the next plank into the clips that were just fixed. Rest on the vertical start profile and place clips onto this new plank and fix into place. Continue until complete.

On installing the final plank, the fixings will be visible. Marley Eternit colour coordinated screws are recommended.

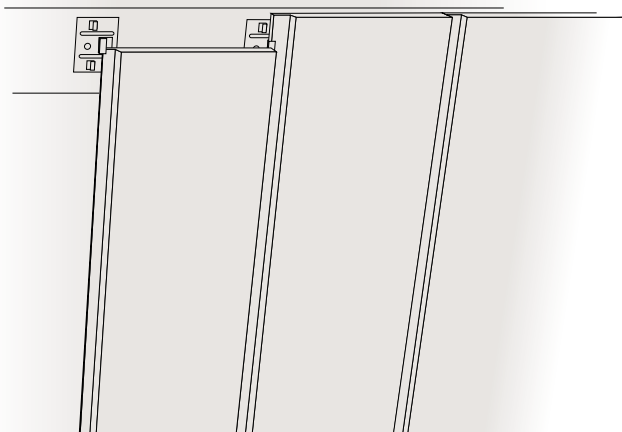

## Preventing efflorescence

Efflorescence or 'lime bloom' is an occasional phenomenon that affects all cement-based products. It is temporary and is in no way detrimental to the performance of the product. Water dissolves salts within the product, this salt solution migrates to the substrate's surface, and a salt deposit remains after the water evaporates. Efflorescence is not normally due to faulty materials.

Cement contains an amount of free lime. When water is added, a series of chemical reactions commence which result in the setting and hardening of the cement, which is accompanied by the release of more lime in the form of Calcium Hydroxide. This salt is sparingly soluble in water and the supersaturated solution deposits crystals on the surface of Cedral.

The prime cause for the onset of efflorescence is the retention of water between the Cedral planks whilst retained in the pack or its installation in very wet conditions. It is recommended that Cedral is stored under cover and clear of the ground prior to being used on site. The polythene wrapper should not be relied on for protection in the open. Care should be taken to prevent excessive moisture running down the rear face of the Cedral during installation. A ventilated cavity behind Cedral will help prevent moisture becoming trapped.

The duration of efflorescence is dependent on the quality and type of deposit and upon prevailing conditions. Water, the element that is initially responsible for its appearance, is also largely responsible for its disappearance.

Rainwater being slightly acidic not only dissolves the deposit, but also mechanically removes it by movement down Cedral. Although it is impossible to state categorically how long efflorescence will take to be removed by wind and rain; a period of suitably bad weather is usually sufficient to restore Cedral to an even appearance.

Washing with warm water and a soft brush can accelerate its removal, however care should be taken to avoid damaging the painted surface. More stubborn deposits can be removed with 9.5% acetic acid. Allow to react for a few minutes but do not allow to dry out, then wash with plenty of cold water. Repeat procedure if required. Try on a small area first to avoid damage.

For CAD details and further information, contact:

Marley Eternit Technical Advisory Service, Lichfield Road, Branston,  
Burton upon Trent, DE14 3HD

Tel: 01283 722588 Website: [www.marleyeternit.co.uk](http://www.marleyeternit.co.uk)

This publication is based on the latest data available at the time of printing. Due to product changes, improvements and other factors, the Company reserves the right to change or withdraw information contained herein without prior notice. For specific applications users should refer to the Technical Advisory Service and relevant Standards and Codes of Practice for guidance.

The photography shown in the document should not necessarily be taken as recommendations of good practice. The printing process restricts the exact representation of colours. For true colour reference, please request product samples.

- ✓ *low maintenance*
- ✓ *factory applied colour*
- ✓ *easy to install*



For further information, please contact  
Tel: 01283 722588 Fax: 01283 722219  
E-mail: [info@marleyeternit.co.uk](mailto:info@marleyeternit.co.uk) [www.cedral.co.uk](http://www.cedral.co.uk)

Marley Eternit Limited, Lichfield Road, Branston, Burton-upon-Trent, DE14 3HD

an **etex** company