

Pioneering for You

wilo

Wilo-Yonos PICO



ErP
READY

APPLIES TO EUROPEAN DIRECTIVE FOR ENERGY RELATED PRODUCTS

en Installation and operating instructions

Fig. 1:

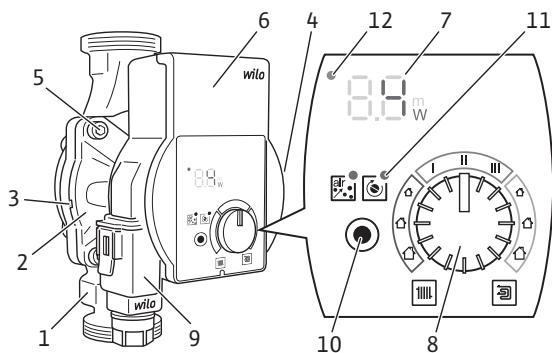

Fig. 2:

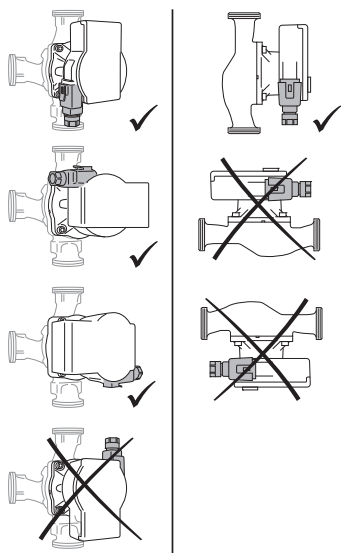

Fig. 3a:

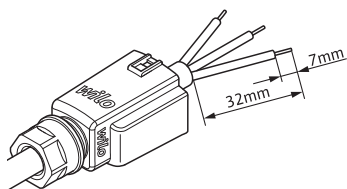

Fig. 3b:

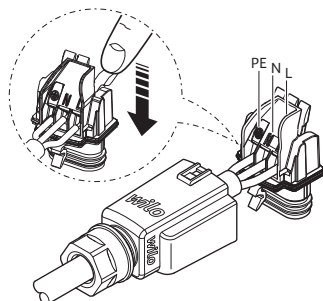

Fig. 3c:

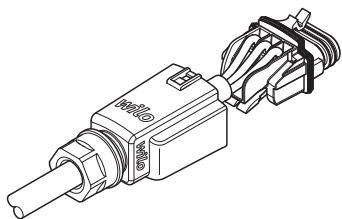

Fig. 3f:

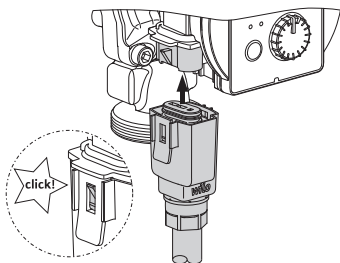

Fig. 3d:

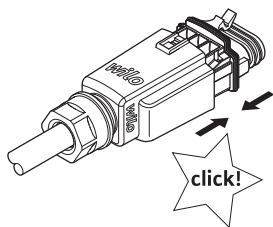

Fig. 4:

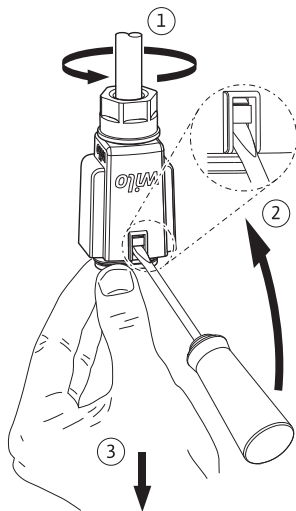
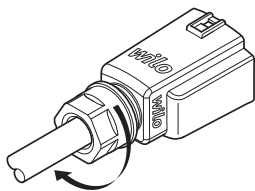

Fig. 3e:



1 General information

About these instructions

These installation and operating instructions are an integral part of the product. Read these instructions before commencing work and keep them in an accessible place at all times.

Strict adherence to these instructions is a precondition for the intended use and correct operation of the product. All information and markings on the product must be observed.

The language of the original operating instructions is German. All other languages of these instructions are translations of the original operating instructions.

2 Safety

This chapter contains basic information which must be adhered to during installation, operation and maintenance. Additionally, the instructions and safety instructions in the other chapters must be observed.

Failure to follow the installation and operating instructions will result in risk of injury to persons and damage to the environment and the product. This will result in the loss of any claims for damages.

Failure to follow the instructions will, for example, result in the following risks:

- Danger to persons due to electrical, mechanical and bacteriological factors as well as electromagnetic fields
- Environmental risks due to leakage of hazardous substances
- Property damage
- Failure of important functions of the product

Identification of safety instructions

These installation and operating instructions set out safety instructions for preventing personal injury and damage to property that are displayed in different ways:

- Safety instructions relating to personal injury start with a signal word and are **preceded by a corresponding symbol**.

- Safety instructions relating to property damage start with a signal word and are displayed **without** a symbol.

Signal words **DANGER!**

Failure to observe the safety instructions will result in serious injuries or death!

WARNING!

Failure to follow the instructions can lead to (serious) injuries!

CAUTION!

Failure to follow the instructions can lead to property damage and a possible total loss.

NOTE

Useful information on handling the product.

Symbols These instructions use the following symbols:



Danger due to electrical voltage



General danger symbol



Warning of hot surfaces/media



Warning of magnetic fields



Notes

Personnel qualifications

Personnel must:

- Be instructed in the locally applicable accident prevention regulations.
- Have read and understood the installation and operating instructions.

Personnel must have the following qualifications:

- Electrical work must be carried out by an authorised electrician (in accordance with EN 50110-1).

- Installation/dismantling must be carried out by a qualified technician who is trained in the use of the necessary tools and mounting materials.
- The product must be operated by persons who are instructed in the functioning of the complete system.

Definition of “qualified electrician”

A qualified electrician is a person with appropriate technical education, knowledge and experience who can identify and prevent electrical hazards.

Electrical work

- Electrical work must be performed by a qualified electrician.
- Nationally applicable guidelines, standards and regulations as well as specifications by local energy supply companies for connection to the local power supply system must be observed.
- Before commencing work, disconnect the product from the mains and secure it against being switched on again.
- The connection must be protected by means of a residual-current device (RCD).
- The product must be earthed.
- Have defective cables replaced immediately by a qualified electrician.
- Never open the control module and never remove control elements.

Obligations of the operator

- Have all work carried out by qualified personnel only.
 - Ensure on-site contact protection from hot components and electrical hazards.
 - Have defective gaskets and connecting cables replaced.
- This device can be used by children from 8 years old as well as persons with limited physical, sensory or mental capabilities or lack of experience and knowledge, if they are supervised or instructed in the safe use of the device and they understand the dangers that may arise. Children are not allowed to play with the device. Cleaning and user maintenance may not be carried out by children without supervision.

3 Product description and function

- Overview** Wilo-Yonos PICO (Fig. 1)
- 1 Pump housing with screwed connections
 - 2 Glandless pump motor
 - 3 Condensate drain openings
(4x around circumference)
 - 4 Rating plate
 - 5 Housing screws
 - 6 Control module
 - 7 LED display
 - 8 Operating button
 - 9 Wilo-Connector, electrical mains connection
 - 10 Function key
 - 11 Function LED
 - 12 Fault signal LED

Function High-efficiency circulator for hot-water heating systems with integrated differential pressure control. Control mode and delivery head (differential pressure) are adjustable. The differential pressure is controlled via the pump speed.

Type key

Example: Wilo-Yonos PICO 25/1-6 130

Yonos PICO	High-efficiency circulator
25	Screwed connection DN 25 (Rp 1)
1-6	1 = Minimum delivery head in m (adjustable down to 0.5 m) 6 = Maximum delivery head in m at $Q = 0 \text{ m}^3/\text{h}$
130	Port-to-port length: 130 mm or 180 mm

Technical data

Connection voltage	1 ~ 230 V ± 10 %, 50/60 Hz
Protection class IP	See rating plate (4)
Energy efficiency index EEI	See rating plate (4)
Fluid temperatures at max. ambient temperature +40 °C	-10 °C to +95 °C
Fluid temperatures at max. ambient temperature +25 °C	-10 °C to +110 °C
Permitted ambient temperature	-10 °C to +40 °C
Max. operating pressure	10 bar (1000 kPa)
Min. inlet pressure at +95 °C/+110 °C	0.3 bar/1.0 bar (30 kPa/100 kPa)

LED display



- Display of the current power consumption in W .



- Display of the setpoint H of the delivery head (differential pressure) in m .



- Display of selected constant speed (c1 = I, c2 = II, c3 = III).

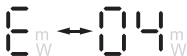

- Display of warning and fault signals.

3.1 Controls

Operating button

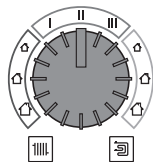

- Turn
- Select application/control mode.
- Set setpoint H of the delivery head (differential pressure).
- Select constant rotation speed.

Function key Press

- Start pump venting function.
- activate pump manual restart.



3.2 Applications/control mode and functions

Radiator heating system

Recommended for two-pipe heating systems with radiators to reduce the flow noises at the thermostatic valves.

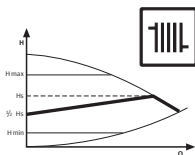

Variable differential pressure ($\Delta p-v$):

The pump reduces the delivery head at a decreasing volume flow in the pipe network to half.

Electrical energy saving by adjusting the delivery head to the volume flow requirement and lower flow rates.



NOTE

Factory setting: $\Delta p-v, \frac{1}{2} H_{max}$

Underfloor heating

Recommended for underfloor heating.

Or for large-sized pipes as well as all applications without changeable pipe network curve (e.g. storage charge pumps) as well as single-pipe heating systems with radiators.

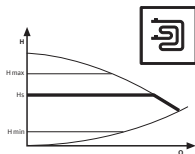

Constant differential pressure ($\Delta p-c$):

The controller keeps the set delivery head constant irrespective of the conveyed volume flow.

Constant speed

Recommended for systems with fixed system resistance requiring a constant volume flow.

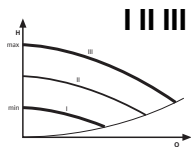

Constant speed (I, II, III):

The pump runs uncontrolled in three prescribed fixed speed stages.

Venting



The **pump venting function** is activated via the function key and vents the pump automatically.

The heating system is not vented.

Manual restart



A **manual restart** is activated via the function key and deblocks the pump as required (e.g. after a prolonged standstill during the summer).

4 Intended use

The high-efficiency circulators in the Wilo-Yonos PICO series are exclusively designed for circulating fluids in hot-water heating systems and similar systems with constantly changing volume flows.

Permitted fluids:

- Heating water according to VDI 2035 (CH: SWKI BT 102-01).
- Water-glycol mixtures* with a maximum of 50 % glycol.

* Glycol has a higher viscosity than water. If glycol is added, the delivery data of the pump must be corrected to suit the mixing ratio.



NOTE

Only add ready-to-use mixtures to the system. Do not use the pump to mix the fluid in the system.

Intended use includes observing these instructions and the data and markings on the pump.

Misuse Any use beyond the intended use is considered misuse and will result in the loss of all liability claims.



WARNING!

Danger of injury or material damage due to improper use!

- Never use non-specified fluids.
- Never allow unauthorised persons to perform work.
- Never operate the pump outside of the specified limits of use.
- Never carry out unauthorised conversions.
- Use authorised accessories only.
- Never operate with phase angle control.

5 Transportation and storage

Scope of delivery

- High-efficiency circulator with 2 gaskets
- Wilo-Connector
- Installation and operating instructions

Transport inspection Inspect for transportation damage and check completeness immediately after delivery, and claim immediately if necessary.

Transport and storage conditions Protect from moisture, frost and mechanical loads. Permissible temperature range: -10 °C to +50 °C.

6 Installation and electrical connection

6.1 Installation

May only be installed by qualified technicians.



WARNING!

Risk of burns due to hot surfaces!

Pump housing (1) and glandless pump motor (2) may become hot and result in burns on contact.

- During operation, touch the control module (6) only.
- Allow the pump to cool down before commencing any work.



WARNING!

Risk of burns due to hot fluids!

Hot fluids can result in scalding. Before installing or removing the pump, or undoing the housing screws (5), note the following:

- Allow the heating system to cool down completely.
- Close shut-off devices or drain the heating system.

Preparation

- Choose an installation point that is as easily accessible as possible.
- Observe the pump's allowable installation position (Fig. 2), rotate the motor head (2 + 6) if necessary.

CAUTION!

An incorrect installation position may damage the pump.

- Select the installation point in line with the allowable installation position (Fig. 2).
 - The motor must always be installed horizontally.
 - The electrical connection must never face upwards.
-

- Install shut-off devices upstream and downstream of the pump to facilitate pump replacement.

CAUTION!

Leaking water may damage the control module.

- Align the upper shut-off device such that leaking water cannot drip onto the control module (6).

- Align the upper shut-off device laterally.
- When installing in the feed of open systems, the safety supply must branch off upstream of the pump (EN 12828).
- Complete all welding and brazing tasks.
- Flush the pipe system.

Rotating the motor head

Rotate the motor head (2 + 6) before installing and connecting the pump.

- If necessary, remove the thermal insulation shell.



WARNING!

Risk of fatal injury from magnetic field!

Risk of death for people with medical implants due to permanent magnets installed in the pump.

- Never remove the rotor.

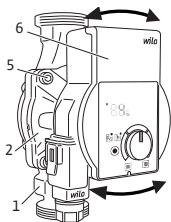

- Hold the motor head (2 + 6) and unscrew the 4 housing screws (5).

CAUTION!

Damage to the inner gasket leads to leakages.

- Carefully rotate the motor head (2 + 6) without removing it from the pump housing (1).
- Carefully rotate the motor head (2 + 6).
- Observe the allowable installation position (Fig. 2) and the direction arrow on the pump housing (1).
- Tighten the 4 housing screws (5).

Installing the pump

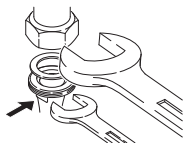
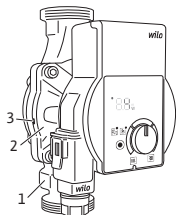

Observe the following points when installing the pump:

- Note the direction arrow on the pump housing (1).
- Install without tension, with glandless pump motor horizontal (2).
- Place gaskets in the screwed connections.
- Screw on threaded pipe unions.
- Secure the pump with an open-end wrench against twisting and screw tightly with the piping
- Re-mount the thermal insulation shell, if applicable.

CAUTION!

Insufficient heat dissipation and condensation water may damage the control module and the glandless pump motor.

- Do not thermally insulate the glandless pump motor (2).
- Ensure all condensate drain openings (3) are kept free.

6.2 Electrical connection

The electrical connection may only be performed by a qualified electrician.



DANGER!

Danger to life due to electrical voltage!

Immediate danger to life if live components are touched.

- Before commencing work, switch off the power supply and secure it against being switched on again.
- Never open the control module (6) and never remove control elements.

CAUTION!

Pulsed mains voltage can lead to damage to electronic components.

- Never operate the pump with phase angle control.
 - When switching the pump on or off using an external control unit, deactivate any voltage pulsing (e.g. phase angle control).
 - For applications where it is not clear whether the pump is operated with pulsed voltage, get the control/system manufacturer to confirm that the pump is operated with sinusoidal AC voltage.
 - Switching the pump on/off via triacs/solid-state relays must be examined on a case-by-case basis.
-

Preparation

- The current type and voltage must agree with the specifications on the rating plate (4).
- Maximum back-up fuse: 10 A, slow-blow.
- Only operate the pump with sinusoidal AC voltage.
- Note switching frequency:
 - On/off switching operations via mains voltage $\leq 100/24$ h.
 - $\leq 20/h$ for a switching frequency of 1 min. between switching on/off via mains voltage.
- The electrical connection must be made via a fixed connecting cable equipped with a connector device or an all-pole switch with a contact opening width of at least 3 mm (VDE 0700/Part 1).
- Use a connecting cable with a sufficient outer diameter (e.g. H05VV-F3G1.5) to protect against leaking water and to ensure strain relief at the threaded cable connection.
- Use a heat-resistant connecting cable where fluid temperatures exceed 90 °C.
- Ensure that the connecting cable does not make contact with either the pipes or the pump.

Fitting the Wilo-Connector

- Disconnect the connecting cable from the power supply.
- Observe the terminal allocations (PE, N, L).
- Connect and fit the Wilo-Connector (Fig. 3a to 3e).

Connecting the pump

- Earth the pump.
- Connect the Wilo-Connector (9) to the control module (6) until it snaps into place (Fig 3f).

Removing the Wilo-Connector

- Disconnect the connecting cable from the power supply.
- Remove the Wilo-Connector using a suitable screwdriver (Fig. 4).

7 Commissioning

Commissioning only by qualified technicians.

7.1 Venting

- Fill and vent the system correctly.
- ↳ The pump vents automatically when first started.

If the pump does not vent automatically:

- Activate the pump venting function via the function key, briefly press 1x, LED lights green.
- ↳ Pump venting function starts after 5 seconds, duration 10 minutes.
- ↳ LED display shows bars running from bottom to top.
- To cancel, press the function key for a couple of seconds.



NOTE

After venting, the LED display shows the previously set values of the pump.

7.2 Setting the control mode and the delivery head

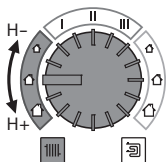

The size of the displayed house symbols and data for setting the delivery head are provided as a guide only. A more detailed calculation for the setting is recommended. The values of the delivery head are displayed in increments of 0.1 m with the setting.

Radiator heating system



Variable differential pressure ($\Delta p-v$):

- Select the setting range of the application.
 - Set setpoint H of the delivery head (variable differential pressure).
- ➔ The LED display shows the setpoint H of the delivery head in *m*.

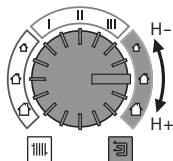

Pump	Number of radiators		
			
Yonos PICO.../1-4 m	8	12	15
Yonos PICO.../1-6 m	12	15	20
Yonos PICO.../1-8 m	15	20	30

Underfloor heating



Constant differential pressure ($\Delta p-c$):

- Select the setting range of the application.
 - Set setpoint H of the delivery head (constant differential pressure).
- ➔ The LED display shows the setpoint H of the delivery head in *m*.

Pump	Number of square metres of heated space in m ²		
			
Yonos PICO.../1-4 m	-	80	120
Yonos PICO.../1-6 m	80	150	220
Yonos PICO.../1-8 m		> 220	

Constant speed

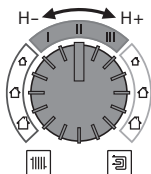

Constant speed I II III:

- Select the setting range of the constant speed.
- Select speed stage I II or III.
- ➔ The LED display shows the set speed c1, c2 or c3 according to the characteristic curve.

Completing the setting

- Do not rotate the operating button for 2 seconds.
- LED display flashes 5 times and changes to the current power consumption in *W*.



NOTE

All settings and displays are retained if the power supply is interrupted.

8 Decommissioning

Shutting down the pump

Shut down the pump immediately in case of damage to the connecting cable or other electrical components.

- Disconnect the pump from the power supply.
- Contact Wilo customer service or a specialist technician.

9 Maintenance

Cleaning

- Carefully remove soiling from the pump on a regular basis using a dry duster.
- Never use liquids or aggressive cleaning agents.

10 Faults, causes and remedies

The troubleshooting must only be performed by a qualified specialist, work on the electrical connection must only be performed by a qualified electrician.

Faults	Causes	Remedies
Pump is not running although the power supply is switched on	Electrical fuse defective	Check fuses
	Pump has no voltage	Resolve the power interruption
Pump making noises	Cavitation due to insufficient suction pressure	Increase the system pressure within the permissible range
		Check the delivery head and set it to a lower head if necessary
Building does not get warm	Thermal output of the heating surfaces is too low	Increase setpoint
		Set control mode to $\Delta p-c$

10.1 Warning signals

- The warning signal is indicated by the LED display.
- Fault signal LED does not light up.
- The pump continues to run with limited output.
- The indicated faulty operating status must not occur for a prolonged period. The cause must be eliminated.

LED	Faults	Causes	Remedies
E07	Generator operation	Water is flowing through the pump hydraulics, but pump has no mains voltage	Check mains voltage
E11	Dry run	Air in the pump	Check volumetric flow rate/water pressure
E21	Overload	Sluggish motor, pump is operated outside of its specifications (e.g. high module temperature). The speed is lower than during normal operation.	Check the ambient conditions

10.2 Fault signals

- The fault signal is indicated by the LED display.
- Fault signal LED lights up red.
- The pump switches off (depending on the error code) and attempts a cyclical restart.

LED	Faults	Causes	Remedies
E04	Undervoltage	Power supply too low on mains side	Check mains voltage
E05	Overvoltage	Power supply too high on mains side	Check mains voltage
E10	Blocking	Rotor blocked	Activate manual restart or contact customer service
E23	Short-circuit	Motor current too high	Request customer service
E25	Contacting/ winding	Winding defective	Request customer service
E30	Excessive temperature of module	Module interior too warm	Check conditions of use
E36	Module defective	Electronics defective	Request customer service

Manual restart

- The pump attempts an automatic restart upon detecting a blockage.



If the pump does not restart automatically (E10):

- Activate the manual restart via the function key, briefly press 2x, LED lights green.
- ➔ A restart is performed after 5 seconds, duration 10 minutes.
- ➔ LED display shows the outer segments in a clockwise fashion.
- To cancel, press the function key for a couple of seconds.



NOTE

After the restart, the LED display shows the previously set values of the pump.

If the fault cannot be remedied, contact a specialist technician or Wilo customer service.

11 Disposal

Information on the collection of used electrical and electronic products

Proper disposal and appropriate recycling of this product prevents damage to the environment and dangers to your personal health.



NOTE

Disposal in domestic waste is forbidden!

In the European Union, this symbol can appear on the product, the packaging or the accompanying documentation. It means that the electrical and electronic products in question must not be disposed of along with domestic waste.

To ensure proper handling, recycling and disposal of the used products in question, please note the following points:

- Only hand over these products at designated, certified collecting points.
- Observe the locally applicable regulations!

Please consult your local municipality, the nearest waste disposal site, or the dealer who sold the product to you for information on proper disposal. For further information on recycling, go to www.wilo-recycling.com.

EU/EG KONFORMITÄTSERKLÄRUNG
EU/EC DECLARATION OF CONFORMITY
DECLARATION DE CONFORMITE UE/CE

Als Hersteller erklären wir unter unserer alleinigen Verantwortung, dass die Nassläufer-Umwälzpumpen der Baureihe,
We, manufacturer, declare under our sole responsibility that these glandless circulating pump types of the series,
Nous, fabricant, déclarons sous notre seule responsabilité que les types de circulateurs de la série,

Yonos PICO ...

(Die Seriennummer ist auf dem Typenschild des Produktes angegeben / The serial number is marked on the product site plate / Le numéro de série est inscrit sur la plaque signalétique du produit)

in der gelieferten Ausführung folgenden einschlägigen Bestimmungen entsprechen :
In their delivered state comply with the following relevant directives :
dans leur état de livraison sont conformes aux dispositions des directives suivantes :

- _ **Niederspannungsrichtlinie 2014/35/EU**
- _ **Low voltage 2014/35/EU**
- _ **Basse tension 2014/35/UE**

- _ **Elektromagnetische Verträglichkeit-Richtlinie 2014/30/EU**
- _ **Electromagnetic compatibility 2014/30/EU**
- _ **Compatibilité électromagnétique 2014/30/UE**

- _ **Richtlinie energieverbrauchsrelevanter Produkte 2009/125/EG**
- _ **Energy-related products 2009/125/EC**
- _ **Produits liés à l'énergie 2009/125/CE**

Nach den Okodesign-Anforderungen der Verordnung 641/2009 für Nassläufer-Umwälzpumpen , die durch die Verordnung 622/2012 geändert wird
This applies according to eco-design requirements of the regulation 641/2009 for glandless circulators amended by the regulation 622/2012
suivant les exigences d'éco-conception du règlement 641/2009 pour les circulateurs, amendé par le règlement 622/2012

und entsprechender nationaler Gesetzgebung,
and with the relevant national legislation,
et aux législations nationales les transposant,

sowie auch den Bestimmungen zu folgenden harmonisierten europäischen Normen :
comply also with the following relevant harmonized European standards :
sont également conformes aux dispositions des normes européennes harmonisées suivantes :

EN 60335-2-51

EN 16297-1

EN 16297-2

EN 61000-6-1:2007

EN 61000-6-2:2005

EN 61000-6-3+A1:2011

EN 61000-6-4+A1:2011

Dortmund,



Digital
unterscriben von
Holger Herchenhein
Datum: 2017.02.22
18:01:57 +01'00'

H. HERCHENHEIN
Senior Vice President - Group ITQ



WILO SE
Nortkirchenstraße 100
44263 Dortmund - Germany

N°2117812.06 (CE-A-S n°4216446)

<p align="center">(BG) - Български език ДЕКЛАРАЦИЯ ЗА СЪОТТЕТВИЕ ЕО</p> <p>WILO SE декларира, че продуктите посочени в настоящата декларация съответстват на разпоредбите на следните европейски директиви и приелите ги национални законодателства:</p> <p>Ниско Напрежение 2014/35/ЕО; Електромагнитна съвместимост 2014/30/ЕО; Продукти, свързани с енергопотреблението 2009/125/ЕО</p> <p>както и на хармонизираните европейски стандарти, упоменати на предшната страница.</p>	<p align="center">(CS) - Čeština ES PROHLÁŠENÍ O SHODĚ</p> <p>WILO SE prohlašuje, že výrobky uvedené v tomto prohlášení odpovídají ustanovením níže uvedených evropských směrníc a národním právním předpisům, které je přejímají:</p> <p>Nízké Napětí 2014/35/ES; Elektromagnetická Kompatibilita 2014/30/ES; Výrobků spojených se spotřebou energie 2009/125/ES</p> <p>a rovněž splňují požadavky harmonizovaných evropských norem uvedených na předcházející stránce.</p>
<p align="center">(DA) - Dansk EF-OVERENSSTEMMELSESERKLÆRING</p> <p>WILO SE erklærer, at produkterne, som beskrives i denne erklæring, er i overensstemmelse med bestemmelserne i følgende europæiske direktiver, samt de nationale lovgivninger, der gennemfører dem:</p> <p>Lavspændings 2014/35/EF; Elektromagnetisk Kompatibilitet 2014/30/EF; Energirelaterede produkter 2009/125/EF</p> <p>De er ligeledes i overensstemmelse med de harmoniserede europæiske standarder, der er anført på forrige side.</p>	<p align="center">(EL) - Ελληνικά ΔΗΛΩΣΗ ΣΥΜΜΟΡΦΩΣΗΣ ΕΚ</p> <p>WILO SE δηλώνει ότι τα προϊόντα που ορίζονται στην παρούσα ευρωπαϊκά δηλωμένα είναι σύμφωνα με τις διατάξεις των παρακάτω οδηγιών και τις εθνικές νομοθεσίες στις οποίες έχει μεταφερθεί:</p> <p>Χαμηλής Τάσης 2014/35/ΕΚ; Ηλεκτρομαγνητικής συμβατότητας 2014/30/ΕΚ; Συνδεδεμένα με την ενέργεια προϊόντα 2009/125/ΕΚ</p> <p>και επίσης με τα εξής εναρμονισμένα ευρωπαϊκά πρότυπα που αναφέρονται στην προηγούμενη σελίδα.</p>
<p align="center">(ES) - Español DECLARACIÓN CE DE CONFORMIDAD</p> <p>WILO SE declara que los productos citados en la presente declaración están conformes con las disposiciones de las siguientes directivas europeas y con las legislaciones nacionales que les son aplicables:</p> <p>Baja Tensión 2014/35/CE; Compatibilidad Electromagnética 2014/30/CE; Productos relacionados con la energía 2009/125/CE</p> <p>Y igualmente están conformes con las disposiciones de las normas europeas armonizadas citadas en la página anterior.</p>	<p align="center">(ET) - Eesti keel EÜ VASTAVUSDEKLARATSIOONI</p> <p>WILO SE kinnitab, et selles vastavustunnistuses kirjeldatud tooted on kooskõlas alljärgnevat Euroopa direktiivide sätetega ning riiklike seadusandlustega, mis nimetatud direktiivid üle on võtnud:</p> <p>Madalpingeseadmed 2014/35/EÜ; Elektromagnetilist Ühilduvust 2014/30/EÜ; Energiagaõuga toodete 2009/125/EÜ</p> <p>Samuti on tooted kooskõlas eelmisel leheküljel ära toodud harmoniseeritud Euroopa standardidega.</p>
<p align="center">(FI) - Suomen kieli EY-VAATIMUSTENMUKAISUUSVAKUUTUS</p> <p>WILO SE vakuuttaa, että tässä vakuutuksessa kuvattut tuotteet ovat seuraavien eurooppalaisten direktiivien määrätysten sekä niihin sovellettävien kansallisten lakiasetusten mukaisia:</p> <p>Matala Jännite 2014/35/EY; Sähkömagneettinen Yhteensopivuus 2014/30/EY; Energiaan liittyvien tuotteiden 2009/125/EY</p> <p>Lisäksi ne ovat seuraavien edellisellä sivulla mainittujen yhdenmukaistettujen eurooppalaisten normien mukaisia.</p>	<p align="center">(GA) - Gaeilge EC DEARBHŪ COMHLÍONTA</p> <p>WILO SE ndearbháilonn an cur síos ar na táirgí atá i ráiteas seo, siad i gcomhréir leis na forálacha atá sna treochra seo a leanas na hEorpa agus leis na dlíthe náisiúnta is infheidhme orthu:</p> <p>Iásealvoltaics 2014/35/EC; Comhoiriúnacht Leictreamaighnéadach 2014/30/EC; Fuinneamh a bhaineann le táirgí 2009/125/EC</p> <p>Agus siad i gcomhréir le forálacha na caighdeán chomhchuíbhithe na hEorpa dá dtagraítear sa leathanach roimhe seo.</p>
<p align="center">(HR) - Hrvatski EZ IZJAVA O SUKLADNOSTI</p> <p>WILO SE izjavljaju da su proizvodi navedeni u ovoj izjavi u skladu sa sljedećim prihvaćenim europskim direktivama i nacionalnim zakonima:</p> <p>Smjernica o niskom naponu 2014/35/EZ; Elektromagnetna kompatibilnost - smjernica 2014/30/EZ; Smjernica za proizvode relevantne u pogledu potrošnje energije 2009/125/EZ</p> <p>i usklađenim europskim normama navedenim na prethodnoj stranici.</p>	<p align="center">(HU) - Magyar EK-MEGFELELŐSÉGI NYILATKOZAT</p> <p>WILO SE kijelenti, hogy a jelen megfelelősségi nyilatkozatban megjelölt termékek megfelelnek a következő európai irányelvek előírásainak, valamint azok nemzeti jogrendbe áttüzetett rendelkezésének:</p> <p>Alacsony Feszültségű 2014/35/EK; Elektromágneses összeférhetőségre 2014/30/EK; Energiával kapcsolatos termékek 2009/125/EK</p> <p>valamint az előző oldalon szereplő, harmonizált európai szabványoknak.</p>
<p align="center">(IS) - Íslenska EB LEYFISYFIRLÝSING</p> <p>WILO SE lýsir því yfir að vörurnar sem og getur í þessari yfirlýsingu eru í samræmi við eftirfarandi tilskipunum ESB og landslögum hafa samþykkt:</p> <p>Lágspennutílskipun 2014/35/EB; Rafseguls-samhæfni-tílskipun 2014/30/EB; Tílskipun varðandi vörur tengdar orkunotkun 2009/125/EB</p> <p>og samhæfða evrópska staðla sem nefnd eru í fyrri síðu.</p>	<p align="center">(IT) - Italiano DICHIARAZIONE CE DI CONFORMITÀ</p> <p>WILO SE dichiara che i prodotti descritti nella presente dichiarazione sono conformi alle disposizioni delle seguenti direttive europee nonché alle legislazioni nazionali che le traspongono:</p> <p>Bassa Tensione 2014/35/CE; Compatibilità Elettromagnetica 2014/30/CE; Prodotti connessi all'energia 2009/125/CE</p> <p>E sono pure conformi alle disposizioni delle norme europee armonizzate citate a pagina precedente.</p>
<p align="center">(LT) - Lietuvių kalba EB ATITIKTIKIES DEKLARACIJA</p> <p>WILO SE pareiškia, kad šioje deklaracijoje nurodyti gaminiai atitinka šių Europos direktyvų ir jas perkėliančių nacionalinių įstatymų nuostatus:</p> <p>Žema įtampa 2014/35/EB; Elektromagnetinis Suderinamumas 2014/30/EB; Energija susijusiems gaminiams 2009/125/EB</p> <p>ir taip pat harmonizuotas Europos normas, kurios buvo cituotos ankstesniame puslapyje.</p>	<p align="center">(LV) - Latviešu valoda EK ATBILSTĪBAS DEKLARĀCIJU</p> <p>WILO SE deklarē, ka izstrādājumi, kas ir nosaukti šajā deklarācijā, atbilst šeit uzskaitīto Eiropas direktīvu nosaucumiem, kā arī atsevišķu valstu likumiem, kuros tie ir ietverti:</p> <p>Zemsprieguma 2014/35/EK; Elektromagnētiskās Saderības 2014/30/EK; Enerģiju saistītiem ražojumiem 2009/125/EK</p> <p>un saskaņotajiem Eiropas standartiem, kas minēti iepriekšējā lappusē.</p>

<p align="center">(MT) - Malti</p> <p align="center">DIKJARAZZJONI KE TA' KONFORMITÀ</p> <p>WILO SE jiddikjarja li l-prodotti speċifikati f'din id-dikjarazzjoni huma konformi mad-direttivi Ewropej li jsegwu u mal-legislazzjonijiet nazzjonali li japplikawhom:</p> <p>Vultagġ Baxx 2014/35/KE ; Kompatibbiltà Elektromanjetika 2014/30/KE ; Prodotti relatati mal-enġerija 2009/125/KE</p> <p>kif ukoll man-normi Ewropej armonizzati li jsegwu imsemmija fil-paġna preċedenti.</p>	<p align="center">(NL) - Nederlands</p> <p align="center">EG-VERKLARING VAN OVEREENSTEMMING</p> <p>WILO SE verklaart dat de in deze verklaring vermelde producten voldoen aan de bepalingen van de volgende Europese richtlijnen evenals aan de nationale wetgevingen waarin deze bepalingen zijn overgenomen:</p> <p>Laagspannings 2014/35/EG ; Elektromagnetische Compatibiliteit 2014/30/EG ; Energierelateerde producten 2009/125/EG</p> <p>De producten voldoen eveneens aan de geharmoniseerde Europese normen die op de vorige pagina worden genoemd.</p>
<p align="center">(NO) - Norsk</p> <p align="center">EU-OVERENSSTEMMELSESERKLAERING</p> <p>WILO SE erklærer at produktene nevnt i denne erklæringen er i samsvar med følgende europeiske direktiver og nasjonale lover:</p> <p>EG-Lavspenningsdirektiv 2014/35/EG ; EG-EMV-Elektromagnetisk kompatibilitet 2014/30/EG ; Direktiv energirelaterede produkter 2009/125/EF</p> <p>og harmoniserte europeiske standarder nevnt på forrige side.</p>	<p align="center">(PL) - Polski</p> <p align="center">DEKLARACJA ZGODNOŚCI WE</p> <p>WILO SE oświadcza, że produkty wymienione w niniejszej deklaracji są zgodne z postanowieniami następujących dyrektyw europejskich i transponującymi je przepisami prawa krajowego:</p> <p>Niskich Napięć 2014/35/WE ; Kompatybilności Elektromagnetycznej 2014/30/WE ; Produktów związanych z energią 2009/125/WE</p> <p>oraz z następującymi normami europejskich zharmonizowanymi podanymi na poprzedniej stronie.</p>
<p align="center">(PT) - Português</p> <p align="center">DECLARAÇÃO CE DE CONFORMIDADE</p> <p>WILO SE declara que os materiais designados na presente declaração obedecem às disposições das diretivas europeias e às legislações nacionais que as transcrevem :</p> <p>Baixa Voltagem 2014/35/CE ; Compatibilidade Electromagnética 2014/30/CE ; Produtos relacionados com o consumo de energia 2009/125/CE</p> <p>E obedecem também às normas europeias harmonizadas citadas na página precedente.</p>	<p align="center">(RO) - Română</p> <p align="center">DECLARAȚIE DE CONFORMITATE CE</p> <p>WILO SE declară că produsele citate în prezenta declarație sunt conforme cu dispozițiile directivelor europene următoare și cu legislațiile naționale care le transpun :</p> <p>Joasă Tensiune 2014/35/CE ; Compatibilitate Electromagnetică 2014/30/CE ; Produselor cu impact energetic 2009/125/CE</p> <p>și, de asemenea, sunt conforme cu normele europene armonizate citate în pagina precedentă.</p>
<p align="center">(RU) - русский язык</p> <p align="center">Декларация о соответствии Европейским нормам</p> <p>WILO SE заявляет, что продукты, перечисленные в данной декларации о соответствии, отвечают следующим европейским директивам и национальным предписаниям:</p> <p>Директива ЕС по низковольтному оборудованию 2014/35/EC ; Директива ЕС по электромагнитной совместимости 2014/30/EC ; Директива о продукции, связанной с энергопотреблением 2009/125/EC и гармонизированным европейским стандартам, упомянутым на предыдущей странице.</p>	<p align="center">(SK) - Slovenčina</p> <p align="center">ES VYHLÁSENIE O ZHODE</p> <p>WILO SE čestne prehlasuje, že výrobky ktoré sú predmetom tejto deklarácie, sú v súlade s požiadavkami nasledujúcich európskych direktív a odporúčajúcich národných legislatívnych predpisov:</p> <p>Nízkonapäťové zariadenia 2014/35/ES ; Elektromagnetická Kompatibilitu 2014/30/ES ; Energeticky významných výrobkov 2009/125/ES</p> <p>ako aj s harmonizovanými európskymi normami uvedenými na predchádzajúcej strane.</p>
<p align="center">(SL) - Slovenščina</p> <p align="center">ES-IZJAVA O SKLADNOSTI</p> <p>WILO SE izjavlja, da so izdelki, navedeni v tej izjavi, v skladu z določili naslednjih evropskih direktiv in z nacionalnimi zakonodajami, ki jih vsebujejo:</p> <p>Nizka Napetost 2014/35/ES ; Elektromagnetno Združljivostjo 2014/30/ES ; Izdelkov, povezanih z energijo 2009/125/ES</p> <p>pa tudi z usklajenimi evropskimi standardi, navedenimi na prejšnji strani.</p>	<p align="center">(SV) - Svenska</p> <p align="center">EG-FÖRSÄKRAN OM ÖVERENSSTÄMMELSE</p> <p>WILO SE intygar att materialet som beskrivs i följande intyg överensstämmer med bestämmelserna i följande europeiska direktiv och nationella lagstiftningar som inför dem:</p> <p>Lågspännings 2014/35/EG ; Elektromagnetisk Kompatibilitet 2014/30/EG ; Energirelaterade produkter 2009/125/EG</p> <p>Det överensstämmer även med följande harmoniserade europeiska standarder som nämnts på den föregående sidan.</p>
<p align="center">(TR) - Türkçe</p> <p align="center">CE UYGUNLUK TEYID BELGESİ</p> <p>WILO SEbu belgede belirtilen ürünlerin aşağıdaki Avrupa yönetmeliklerine ve ulusal kanunlara uygun olduğunu beyan etmektedir:</p> <p>Alçak Gerilim Yönetmeliği 2014/35/AT ; Elektromanyetik Uyumluluk Yönetmeliği 2014/30/AT ; Eko Tasarım Yönetmeliği 2009/125/AT</p> <p>ve önceki sayfada belirtilen uyumlaştırılmış Avrupa standartlarına.</p>	

Wilo – International (Subsidiaries)

Argentina

WILO SALMSON
Argentina S.A.
C1295ABI Ciudad
Autónoma de Buenos Aires
T +54 11 4361 5929
carlos.muschich@wilo.com.ar

Australia

WILO Australia Pty Limited
Murrarie, Queensland, 4172
T +61 7 3907 6900
chris.dayton@wilo.com.au

Austria

WILO Pumpen Österreich
GmbH
2351 Wiener Neudorf
T +43 507 507-0
office@wilo.at

Azerbaijan

WILO Caspian LLC
1065 Baku
T +994 12 5962372
info@wilo.az

Belarus

WILO Bel IOOO
220035 Minsk
T +375 17 3963446
wilo@wilo.by

Belgium

WILO NV/SA
1083 Ganshoren
T +32 2 4823333
info@wilo.be

Bulgaria

WILO Bulgaria EOOD
1125 Sofia
T +359 2 9701970
info@wilo.bg

Brazil

WILO Comercio e Importacao Ltda
Jundiaí – São Paulo – Brasil
13.213-105
T +55 11 2923 9456
wilo@wilo-brasil.com.br

Canada

WILO Canada Inc.
Calgary, Alberta T2A 1S7
T +1 403 2769456
info@wilo-canada.com

China

WILO China Ltd.
101300 Beijing
T +86 10 58041888
wiloobj@wilo.com.cn

Croatia

WILO Hrvatska d.o.o.
10430 Samobor
T +38 51 3430914
wilo-hrvatska@wilo.hr

Cuba

WILO SE
Oficina Comercial
Edificio Simona Apto 105
Siboney, La Habana, Cuba
T +53 5 2795135
T +53 7 272 2330
raul.rodriguez@wilo-cuba.com

Czech Republic

WILO CS, s.r.o.
25101 Cestlice
T +420 234 098711
info@wilo.cz

Denmark

WILO Danmark A/S
2690 Karlslunde
T +45 70 253312
wilo@wilo.dk

Estonia

WILO Eesti OÜ
12618 Tallinn
T +372 6 509780
info@wilo.ee

Finland

WILO Finland OY
02330 Espoo
T +358 207401540
wilo@wilo.fi

France

Wilo Salmson France S.A.S.
53005 Laval Cedex
T +33 2435 95400
info@wilo.fr

Great Britain

WILO (U.K.) Ltd.
Burton Upon Trent
DE14 2WJ
T +44 1283 523000
sales@wilo.co.uk

Greece

WILO Hellas SA
4569 Anixi (Attika)
T +302 10 6248300
wilo.info@wilo.gr

Hungary

WILO Magyarorszag Kft
2045 Törökbalint
(Budapest)
T +36 23 889500
wilo@wilo.hu

India

WILO Mather and Platt Pumps
Private Limited
Pune 411019
T +91 20 27442100
services@matherplatt.com

Indonesia

PT. WILO Pumps Indonesia
Jakarta Timur, 13950
T +62 21 7247676
citrawilo@cbrt.net.id

Ireland

WILO Ireland
Limerick
T +353 61 227566
sales@wilo.ie

Italy

WILO Italia s.r.l.
Via Novogro, 1/A20090
Segrate MI
T +39 25538351
wilo.italia@wilo.it

Kazakhstan

WILO Central Asia
050002 Almaty
T +7 727 312 40 10
info@wilo.kz

Korea

WILO Pumps Ltd.
20 Gangseo, Busan
T +82 51 950 8000
wilo@wilo.co.kr

Latvia

WILO Baltic SIA
1019 Riga
T +371 6714-5229
info@wilo.lv

Lebanon

WILO LEBANON SARL
Jdeideh 1202 2030
Lebanon
T +961 1 888910
info@wilo.com.lb

Lithuania

WILO Lietuva UAB
03202 Vilnius
T +370 5 2136495
mail@wilo.lt

Morocco

WILO Maroc SARL
20250 Casablanca
T +212 (0) 5 22 66 09 24
contact@wilo.ma

The Netherlands

WILO Nederland B.V.
1551 NA Westzaan
T +31 88 9456 000
info@wilo.nl

Norway

WILO Norge AS
0975 Oslo
T +47 22 804570
wilo@wilo.no

Poland

WILO Polska Sp. z o.o.
5-506 Lesznowola
T +48 22 7026161
wilo@wilo.pl

Portugal

Bombas Wilo-Salmson
Sistemas Hidraulicos Lda.
4475-330 Maia
T +351 22 2080350
bombas@wilo.pt

Romania

WILO Romania s.r.l.
077040 Com. Chiajna
Jud. Ilfov
T +40 21 3170164
wilo@wilo.ro

Russia

WILO Rus ooo
123592Moscow
T +7 495 7810690
wilo@wilo.ru

Saudi Arabia

WILO Middle East KSA
Riyadh 11465
T +966 1 4624430
wshoula@watanaiamd.com

Serbia and Montenegro

WILO Beograd d.o.o.
11000 Beograd
T +381 11 2851278
office@wilo.rs

Slovakia

WILO CS s.r.o., org. Zlozka
83106 Bratislava
T +421 2 33014511
info@wilo.sk

Slovenia

WILO Adriatic d.o.o.
1000 Ljubljana
T +386 1 5838130
wilo.adriatic@wilo.si

South Africa

Wilo Pumps SA Pty LTD
1685 Midrand
T +27 11 6082780
patrick.hulley@salmson.co.za

Spain

WILO Iberica S.A.
8806 Alcalá de Henares
(Madrid)
T +34 91 8797100
wilo.iberica@wilo.es

Sweden

WILO NORDIC AB
35033 Växjö
T +46 470 727600
wilo@wilo.se

Switzerland

Wilo Schweiz AG
4310 Rheinfelden
T +41 61 836 80 20
info@wilo.ch

Taiwan

WILO Taiwan CO., Ltd.
24159 New Taipei City
T +886 2 2999 8676
nelson.wu@wilo.com.tw

Turkey

WILO Pompa Sistemleri
San. ve Tic. A.Ş.
34956 İstanbul
T +90 216 2509400
wilo@wilo.com.tr

Ukraine

WILO Ukraina t.o.w.
08130 Kiev
T +38 044 3937384
wilo@wilo.ua

United Arab Emirates

WILO Middle East FZE
Jebel Ali Free zone – South
PO Box 262720 Dubai
T +971 4 880 91 77
info@wilo.ae

USA

WILO USA LLC
Rosemont, IL 60018
T +1 866 945 6872
info@wilo-usa.com

Vietnam

WILO Vietnam Co Ltd.
Ho Chi Minh City, Vietnam
T +84 8 38109975
nkmhinh@wilo.vn

wilo

Pioneering for You

WILO SE
Nortkirchenstraße 100
D-44263 Dortmund
Germany
T +49(0)231 4102-0
F +49(0)231 4102-7363
wilo@wilo.com
www.wilo.com