

# Round / Square Ceiling Arm Round / Square Wall Arm Fitting instructions

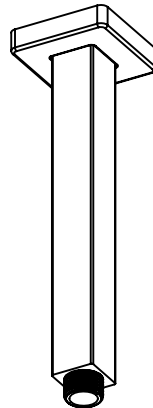
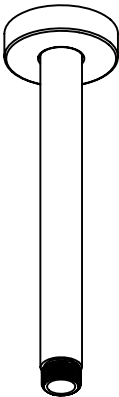
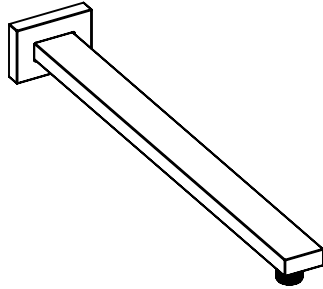
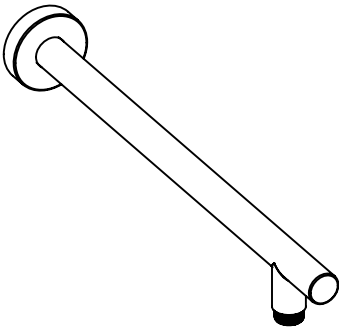

Please keep these instructions for future reference and request of replacement parts.

We have taken great care to ensure that this product reaches you in perfect condition. However should any parts be damaged or missing please contact your point of purchase. This does not affect your statutory rights. In addition if you require replacement parts your point of purchase will be happy to assist.

<b>Contents</b>	<b>Page</b>
<b>1. Tools required</b>	<b>3</b>
<b>2. Parts Supplied</b>	<b>3</b>
<b>3. Specifications</b>	<b>3</b>
<b>4. Installation</b>	<b>3-4</b>
<b>5. Aftercare</b>	<b>4</b>

## Tools required (Tools not supplied)

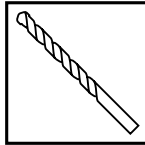
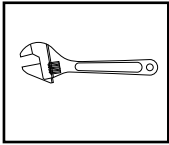

## Parts Supplied

NO.	Description	Qty
1	Shower Arm	1
2	Flange	1
3	Nut ( if supplied)	1
4	Anti-Rotational Washer	1
5	Backnut	1

## Specifications

This arm should be installed in compliance with Water Regulations. For further details contact your Local Water Authority.

- (a) Identify all components and check pack contents.
- (b) Turn off water mains supply.

## Installation

### -Fitting the Round / Square Wall Arm

### -Fitting the Round / Square Ceiling Arm

1. Before installation flush out pipes, and then turn off water supply.
2. Prepare a hole in the desired location of the Shower Arm (1).
3. Determine the length of pipe required to connect the mixer to the Shower Arm (1).  
To do this, Fit the Flange (2) and Nut (3) to the Shower Arm (1), push tail end of Shower Arm (1) through hole in the wall.
4. Place Anti\_Rotational Washer(4) over tail end and secure with Backnut (5).  
Be sure to leave 10mm of pipe to be fitted into tail end.
5. Connect to water supply using suitable plumbing joints.
6. Push Flange (2) to wall until cover all joins.
7. Turn on water supply and check for leaks.

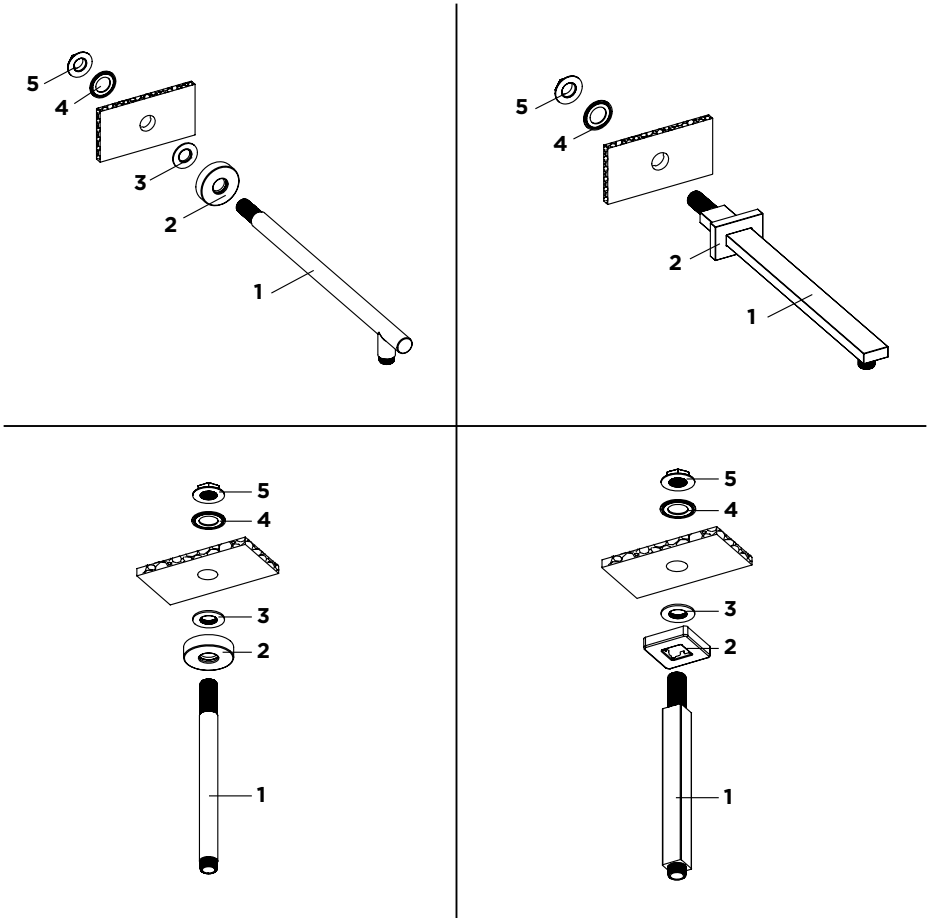

## Aftercare

Whilst modern plating techniques are used in the manufacture of these fittings, the plating will wear if not cleaned properly. The safest way to clean your product is to wipe with a soft damp cloth. Stains can be removed using washing up liquid. All cleaning powders and liquids will damage the surface of your fitting even the non-scratch cleaners.