



Cascada

WC Pan, BTW Pan & Cistern

Installation Instructions

25 YEAR GUARANTEE



Please note: Toilet shown is for illustration purposes only.

**685890 & 685888
& 251803 (WC Pan only)**

Fitting Instructions Cascade WC Pan to Floor



Contents

Item	Description	Qty
1	Floor/Wall Bracket	2
2	Wall Plugs S10 x 50	2
3	Hex Head Screw 6 x 60	2
4	Washer	2
5	S/Steel Screw 5 x 60	2
6	Nylon Bushes	2
7	Chrome Caps	2

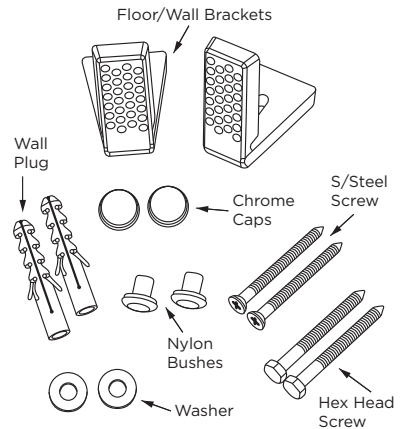

Important: the plugs included in this pack are for solid walls only. If the semi pedestal is to be mounted on a partition or stud wall, specialised fixings should be purchased separately.

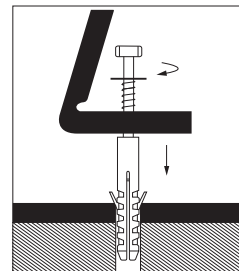
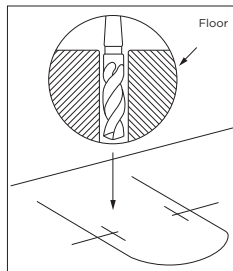
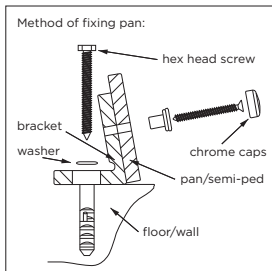

Drill dia 10mm, approx 40mm from the edge of the pan.
Minimum drill hole depth 60mm

Tighten fixing bracket

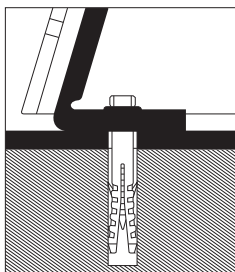

Put on the new WC Pan

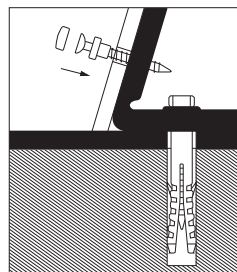

Tighten the screws

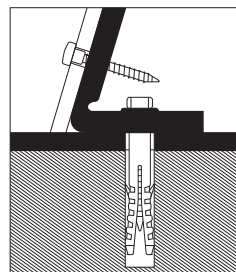

Put on the chrome caps

Caution: Take great care when drilling floors or walls to avoid wires and pipes which may run beneath.

Exercise great care when using power tools near water. The use of a residual current device (RCD) or cordless drill is recommended. Always double-check the position and your measurements before drilling holes. Protective eyewear should be used when drilling. Keep children away from the work area and remember that all small parts, plastic bags and tools should also be kept out of reach of children.

Fixing tip: A piece of insulating tape or a couple of layers of masking tape applied before marking out the fixing holes will help stop the drill from wandering on tiled surfaces.

Fitting Instructions

Cascade Cistern to WC



PLEASE READ THESE INSTRUCTIONS PRIOR TO INSTALLATION.

These instructions must be carried out in order.

- 1) Use this checklist to ensure all parts are accounted for and not damaged. Under no circumstances should this product be installed if any of the parts are damaged or missing. If there are any installation issues please contact your nearest branch.
- 2) Ensure the gasket is a tight fit on the flush valve thread. Place cistern on the WC so the bolts go through the 2 small holes and tighten the hex nuts. Please use the spanner if needed.

Item	Description	Qty
1	S.Steel Bolt	2
2	Rubber Cone Washer	2
3	Rubber Washer	2
4	Steel Washer	4
5	Steel Hex Nut	2
6	EPDM Gasket	1

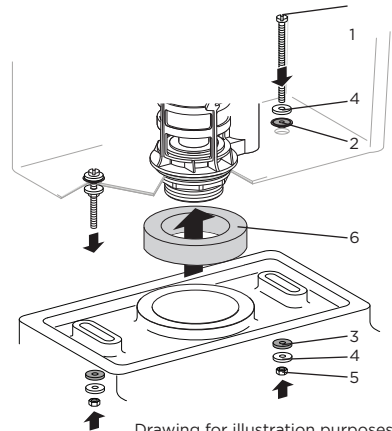

Drawing for illustration purposes only

NOTE - UK water regulations require an isolating valve to be installed to water supply - this is available from your local store if you need to purchase one.

INSTALLING THE PUSH BUTTON

- Open the isolating valve. The inlet valve will shut when the water level reaches the correct level.
- Remove Chrome flush button kit from the bag. Remove both buttons complete with rods. Place the Chrome crown into the cistern lid hole so it fits snug. Align the smaller rod hole over the grey sector on top of the outlet valve. Screw the black nut onto the bezel from the underside of the cistern lid. Mount lid on tank.
- Remove the rods from the buttons. Push rods through the holes on the CP crown and ensure white rod makes contact with the white segment on the top of the valve and the blue rod makes contact with the grey segment.
- Using pliers cut the rods near the top so they are as flush as possible to the top of the Chrome crown. Replace Chrome push buttons on top of the rods.
- Test the flush. Press small button for reduced flush. Press large button for full flush. (Full flush will be needed for solids).

NOTE: Never put any additives/cleaners in the water tank.
PLEASE check all seals for leaks before completing the installation.



CUSTOMER SUPPORT:

We have taken great care to ensure that this product reaches you in perfect condition. However, should any parts be damaged or missing please contact your local branch. This does not affect your statutory rights. In addition if you require replacement parts, your local branch will be only to happy to assist.

JB68946 10/12